

# SMD/BLOCK Type EMI Suppression Filters

# EMIFIL<sup>®</sup>



*Innovator  
in Electronics*

**Murata  
Manufacturing Co., Ltd.**

△Note • Please read rating and △CAUTION (for storage, operating, rating, soldering, mounting and handling) in this catalog to prevent smoking and/or burning, etc.  
• This catalog has only typical specifications because there is no space for detailed specifications. Therefore, please review our product specifications or consult the approval sheet for product specifications before ordering.

C31E.pdf  
Mar.28,2011



## Chip Ferrite Bead

Series Introduction .....	14
Part Numbering .....	16
Series Line Up .....	17
Product Detail .....	22
⚠Caution/Notice .....	90
Soldering and Mounting .....	91
Packaging .....	95
Design Kits .....	96

⚠Note • Please read rating and ⚠CAUTION (for storage, operating, rating, soldering, mounting and handling) in this catalog to prevent smoking and/or burning, etc.  
• This catalog has only typical specifications because there is no space for detailed specifications. Therefore, please review our product specifications or consult the approval sheet for product specifications before ordering.

# BL   Series Introduction

## ● Example of Chip Ferrite Bead BLM Series Structure

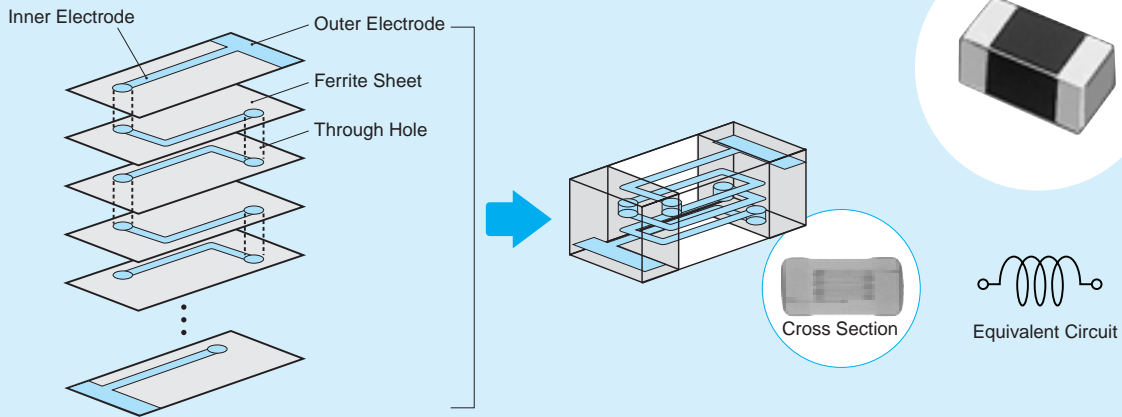

## ● Line Up Classification of Chip Ferrite Bead

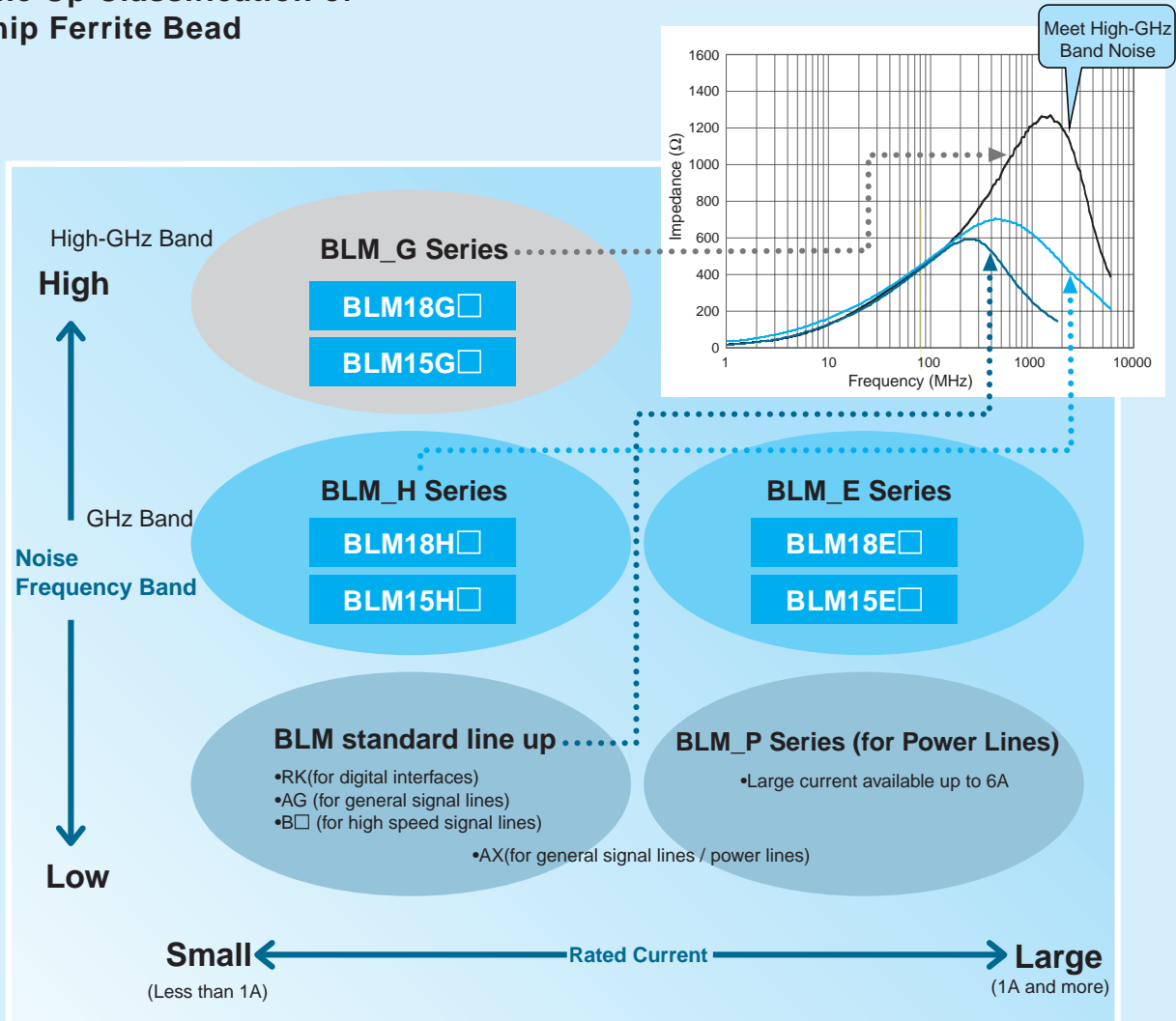

△Note • Please read rating and △CAUTION (for storage, operating, rating, soldering, mounting and handling) in this catalog to prevent smoking and/or burning, etc.  
• This catalog has only typical specifications because there is no space for detailed specifications. Therefore, please review our product specifications or consult the approval sheet for product specifications before ordering.

### ●Difference between BLM A type and B type (HG type vs HD/HB type)

A type: Impedance curve rises from low frequency range. Suppress noise in wide frequency range.  
 B type: Impedance curve rises sharply. Less damage to signal waveforms.

#### ■Comparison of Impedance Curve

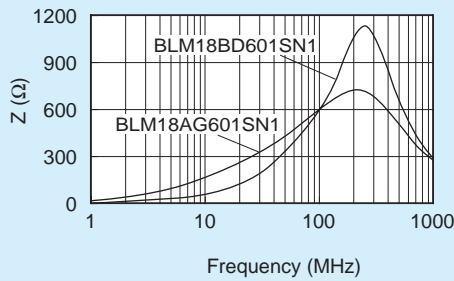

#### ■Comparison of Resistance Element

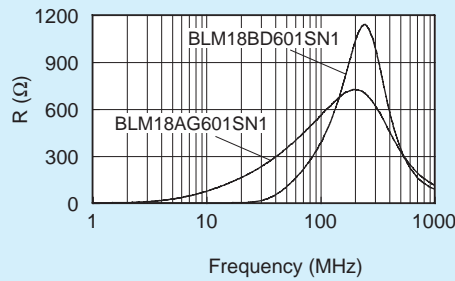

#### ■Comparison of Test Effect (25MHz)

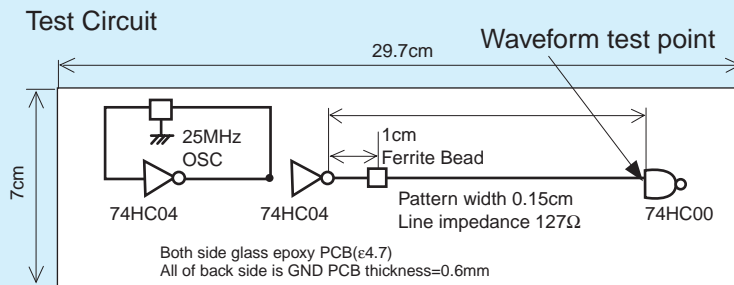

BLM\_B Series has less damage to high speed signal waveform.

Waveform

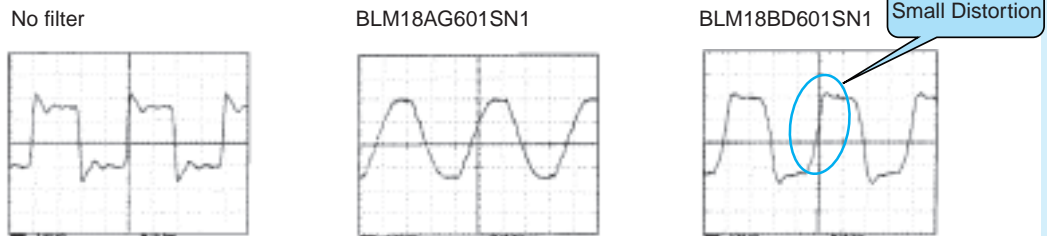

Spectrum

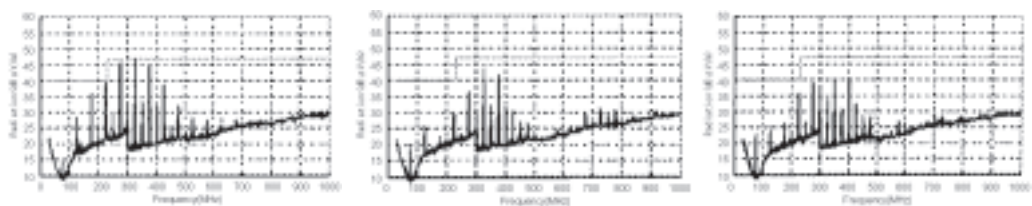

Spectrum has been reduced from low frequency range.

Noise frequency has been reduced without reducing signals of low frequency.

△Note • Please read rating and △CAUTION (for storage, operating, rating, soldering, mounting and handling) in this catalog to prevent smoking and/or burning, etc.  
 • This catalog has only typical specifications because there is no space for detailed specifications. Therefore, please review our product specifications or consult the approval sheet for product specifications before ordering.

# BL   Chip Ferrite Bead Part Numbering

(Part Number) **BL** **M** **18** **AG** **102** **S** **N** **1** **D**

① ② ③ ④ ⑤ ⑥ ⑦ ⑧ ⑨

## ① Product ID

Product ID	
<b>BL</b>	Chip Ferrite Beads

## ② Type

Code	Type
<b>A</b>	Array Type
<b>M</b>	Ferrite Bead Single Type

## ③ Dimensions (L×W)

Code	Dimensions (L×W)	EIA
<b>02</b>	0.4×0.2mm	01005
<b>03</b>	0.6×0.3mm	0201
<b>15</b>	1.0×0.5mm	0402
<b>18</b>	1.6×0.8mm	0603
<b>2A</b>	2.0×1.0mm	0804
<b>21</b>	2.0×1.25mm	0805
<b>31</b>	3.2×1.6mm	1206
<b>41</b>	4.5×1.6mm	1806

## ④ Characteristics/Applications

Code <sup>*1</sup>	Characteristics/Applications	Series
<b>AG</b>	for General Use	<b>BLM02/03/15/18/21, BLA2A/31</b>
<b>AX</b>		<b>BLM03/15</b>
<b>TG</b>		<b>BLM18</b>
<b>BA</b>	for High-speed Signal Lines	<b>BLM15/18</b>
<b>BB</b>		<b>BLM03/15/18/21, BLA2A</b>
<b>BC</b>		<b>BLM03/15</b>
<b>BD</b>		<b>BLM03/15/18/21, BLA2A/31</b>
<b>PD</b>	for Power Supplies	<b>BLM15</b>
<b>PG</b>		<b>BLM03/15/18/21/31/41</b>
<b>PX</b>		<b>BLM15</b>
<b>KG</b>	for Power Supplies (Low DC Resistance Type)	<b>BLM18</b>
<b>SG</b>		
<b>RK</b>	for Digital Interface	<b>BLM18/21</b>
<b>HG</b>	for GHz Band General Use	<b>BLM03/15/18</b>
<b>EG</b>	for GHz Band General Use (Low DC Resistance Type)	<b>BLM15/18</b>
<b>HB</b>	for GHz Band High-speed Signal Lines	<b>BLM15/18</b>
<b>HD</b>		<b>BLM03/15/18</b>
<b>HE</b>		<b>BLM18</b>
<b>HK</b>	for GHz Band Digital Interface	<b>BLM18</b>
<b>GA</b>	for High-GHz Band High-speed Signal Lines	<b>BLM15</b>
<b>GG</b>	for High-GHz Band General Use	<b>BLM15/18</b>

<sup>\*1</sup> Frequency characteristics vary with each code.

## ⑤ Packaging

Code	Packaging	Series
<b>K</b>	Embossed Taping (ø330mm Reel)	<b>BLM21 <sup>*1</sup>/31/41</b>
<b>L</b>	Embossed Taping (ø180mm Reel)	
<b>B</b>	Bulk	All Series
<b>J</b>	Paper Taping (ø330mm Reel)	<b>BLM03/15/18 <sup>*3</sup>/21 <sup>*2</sup>, BLA2A/31</b>
<b>D</b>	Paper Taping (ø180mm Reel)	<b>BLM02/03/15/18/21 <sup>*2</sup>, BLA2A/31</b>

<sup>\*1</sup> BLM21BD222SN1/BLM21BD272SN1 only. <sup>\*2</sup> Except BLM21BD222SN1/BLM21BD272SN1

<sup>\*3</sup> Except BLM18T

## ⑥ Impedance

Expressed by three figures. The unit is in ohm ( $\Omega$ ) at 100MHz. The first and second figures are significant digits, and the third figure expresses the number of zeros which follow the two figures.

## ⑦ Electrode

Expressed by a letter.

Ex.)

Code	Electrode
<b>S/T</b>	Sn Plating
<b>A</b>	Au Plating

## ⑧ Category

Code	Category
<b>N</b>	Standard Type

## ⑨ Number of Circuits

Code	Number of Circuits
<b>1</b>	1 Circuit
<b>4</b>	4 Circuits

<sup>△</sup>Note • Please read rating and <sup>△</sup>CAUTION (for storage, operating, rating, soldering, mounting and handling) in this catalog to prevent smoking and/or burning, etc.  
• This catalog has only typical specifications because there is no space for detailed specifications. Therefore, please review our product specifications or consult the approval sheet for product specifications before ordering.

# BL   Chip Ferrite Bead Series Line Up

Size Code (Inch)	Thickness (mm)	Type	Part Number	Impedance		Rated Current	New	Kit	≥1A	GHz	Flow	ReFlow	
				at 100MHz/20°C	at 1GHz/20°C								
01005	0.2	For General Signal Lines	p46 BLM02AG100SN1	10ohm(Typ.)	-	500mA		Kit				ReFlow	
	0.2		BLM02AG700SN1	70ohm±25%	-	250mA		Kit				ReFlow	
	0.2		BLM02AG121SN1	120ohm±25%	-	200mA		Kit				ReFlow	
	0201	0.3	For General Signal Lines	p47 BLM03AG100SN1	10ohm(Typ.)	-	500mA		Kit				ReFlow
		0.3		BLM03AG700SN1	70ohm(Typ.)	-	200mA		Kit				ReFlow
		0.3		BLM03AG800SN1	80ohm±25%	-	200mA		Kit				ReFlow
		0.3		BLM03AG121SN1	120ohm±25%	-	200mA		Kit				ReFlow
		0.3		BLM03AG241SN1	240ohm±25%	-	200mA		Kit				ReFlow
		0.3		BLM03AG601SN1	600ohm±25%	-	100mA		Kit				ReFlow
		0.3		BLM03AG102SN1	1000ohm±25%	-	100mA		Kit				ReFlow
0.3		Universal Type [Power lines/Signal lines]	p22 BLM03AX100SN1	10ohm(Typ.)	-	1000mA		Kit	≥1A			ReFlow	
0.3			BLM03AX800SN1	80ohm±25%	-	500mA		Kit				ReFlow	
0.3			BLM03AX121SN1	120ohm±25%	-	450mA		Kit				ReFlow	
0.3	BLM03AX241SN1		240ohm±25%	-	350mA		Kit				ReFlow		
0.3	BLM03AX601SN1		600ohm±25%	-	250mA		Kit				ReFlow		
0.3	BLM03AX102SN1		1000ohm±25%	-	200mA		Kit				ReFlow		
0201	0.3	For High Speed Signal Lines (Sharp Impedance Curve)	p57 BLM03BD750SN1	75ohm±25%	-	300mA		Kit				ReFlow	
	0.3		BLM03BD121SN1	120ohm±25%	-	250mA		Kit				ReFlow	
	0.3		BLM03BD241SN1	240ohm±25%	-	200mA		Kit				ReFlow	
	0.3		BLM03BD471SN1	470ohm±25%	-	215mA		Kit				ReFlow	
	0.3		BLM03BD601SN1	600ohm±25%	-	200mA		Kit				ReFlow	
	0.3		BLM03BB100SN1	10ohm±25%	-	300mA		Kit				ReFlow	
	0.3		BLM03BB220SN1	22ohm±25%	-	200mA		Kit				ReFlow	
	0.3		BLM03BB470SN1	47ohm±25%	-	200mA		Kit				ReFlow	
	0.3		BLM03BB750SN1	75ohm±25%	-	200mA		Kit				ReFlow	
	0.3		BLM03BB121SN1	120ohm±25%	-	100mA		Kit				ReFlow	
	0.3		BLM03BC330SN1	33ohm±25%	-	150mA	New	Kit				ReFlow	
	0.3		BLM03BC560SN1	56ohm±25%	-	100mA	New	Kit				ReFlow	
	0.3		BLM03BC800SN1	80ohm±25%	-	100mA	New	Kit				ReFlow	
	0402		0.3	For Power Lines	p30 BLM03PG220SN1	22ohm±25%	-	900mA		Kit			
0.3		BLM03PG330SN1	33ohm±25%		-	750mA		Kit				ReFlow	
0.3		For GHz Band Noise	p75 BLM03HG601SN1	600ohm±25%	1000ohm±40%	150mA		Kit	GHz			ReFlow	
0.3			BLM03HG102SN1	1000ohm±25%	1800ohm±40%	125mA		Kit	GHz			ReFlow	
0.3			p75 BLM03HD331SN1	330ohm±25%	-	200mA	New	Kit	GHz			ReFlow	
0.3			BLM03HD471SN1	470ohm±25%	-	175mA	New	Kit	GHz			ReFlow	
0.3			BLM03HD601SN1	600ohm±25%	-	150mA	New	Kit	GHz			ReFlow	
0.3			BLM03HD102SN1	1000ohm±25%	-	120mA	New	Kit	GHz			ReFlow	
0402		0.5	For General Signal Lines	p49 BLM15AG100SN1	10ohm(Typ.)	-	1000mA		Kit	≥1A			ReFlow
		0.5		BLM15AG700SN1	70ohm(Typ.)	-	500mA		Kit				ReFlow
	0.5	BLM15AG121SN1		120ohm±25%	-	500mA		Kit				ReFlow	
	0.5	BLM15AG221SN1		220ohm±25%	-	300mA		Kit				ReFlow	
	0.5	BLM15AG601SN1		600ohm±25%	-	300mA		Kit				ReFlow	
	0.5	BLM15AG102SN1		1000ohm±25%	-	200mA		Kit				ReFlow	
	0.5	p51 BLM15AG601AN1		600ohm±25%	-	300mA							
	0.5	p51 BLM15AG102AN1	1000ohm±25%	-	200mA								
	0402	0.5	Universal Type [Power lines/Signal lines]	p24 BLM15AX100SN1	10ohm(Typ.)	-	1740mA		Kit	≥1A			ReFlow
		0.5		BLM15AX300SN1	30ohm±25%	-	1100mA	New	Kit	≥1A			ReFlow
0.5		BLM15AX700SN1		70ohm±25%	-	780mA		Kit				ReFlow	
0.5		BLM15AX121SN1		120ohm±25%	-	680mA		Kit				ReFlow	
0.5		BLM15AX221SN1		220ohm±25%	-	580mA		Kit				ReFlow	
0.5		BLM15AX601SN1		600ohm±25%	-	420mA		Kit				ReFlow	
0.5	BLM15AX102SN1	1000ohm±25%	-	350mA		Kit				ReFlow			

Continued on the following page.

△Note • Please read rating and △CAUTION (for storage, operating, rating, soldering, mounting and handling) in this catalog to prevent smoking and/or burning, etc.  
• This catalog has only typical specifications because there is no space for detailed specifications. Therefore, please review our product specifications or consult the approval sheet for product specifications before ordering.

Size Code (Inch)	Thickness (mm)	Type	Part Number	Impedance		Rated Current	New	Kit	≥1A	GHz	Flow	ReFlow
				at 100MHz/20°C	at 1GHz/20°C							
0402	0.5	For High Speed Signal Lines (Sharp Impedance Curve)	p59 BLM15BD750SN1	75ohm±25%	-	300mA	Kit				ReFlow	
	0.5		BLM15BD121SN1	120ohm±25%	-	300mA	Kit				ReFlow	
	0.5		BLM15BD221SN1	220ohm±25%	-	300mA	Kit				ReFlow	
	0.5		BLM15BD471SN1	470ohm±25%	-	200mA	Kit				ReFlow	
	0.5		BLM15BD601SN1	600ohm±25%	-	200mA	Kit				ReFlow	
	0.5		BLM15BD102SN1	1000ohm±25%	-	200mA	Kit				ReFlow	
	0.5		BLM15BD182SN1	1800ohm±25%	-	100mA	Kit				ReFlow	
	0.5		BLM15BB050SN1	5ohm±25%	-	500mA	Kit				ReFlow	
	0.5		BLM15BB100SN1	10ohm±25%	-	300mA	Kit				ReFlow	
	0.5		BLM15BB220SN1	22ohm±25%	-	300mA	Kit				ReFlow	
	0.5		BLM15BB470SN1	47ohm±25%	-	300mA	Kit				ReFlow	
	0.5		BLM15BB750SN1	75ohm±25%	-	300mA	Kit				ReFlow	
	0.5		BLM15BB121SN1	120ohm±25%	-	300mA	Kit				ReFlow	
	0.5		BLM15BB221SN1	220ohm±25%	-	200mA	Kit				ReFlow	
	0.5		BLM15BC121SN1	120ohm±25%	-	350mA	Kit				ReFlow	
	0.5		BLM15BC241SN1	240ohm±25%	-	250mA	Kit				ReFlow	
	0.5		BLM15BA050SN1	5ohm±25%	-	300mA	Kit				ReFlow	
	0.5		BLM15BA100SN1	10ohm±25%	-	300mA	Kit				ReFlow	
	0.5		BLM15BA220SN1	22ohm±25%	-	300mA	Kit				ReFlow	
	0.5		BLM15BA330SN1	33ohm±25%	-	300mA	Kit				ReFlow	
	0.5		BLM15BA470SN1	47ohm±25%	-	200mA	Kit				ReFlow	
	0.5		BLM15BA750SN1	75ohm±25%	-	200mA	Kit				ReFlow	
	0.5		For Power Lines	p31 BLM15PX121SN1	120ohm±25%	-	180mA	New	Kit	≥1A		ReFlow
	0.5			p32 BLM15PG100SN1	10ohm(Typ.)	-	1000mA	Kit		≥1A		ReFlow
	0.5			BLM15PD300SN1	30ohm±25%	-	2200mA	Kit		≥1A		ReFlow
	0.5			BLM15PD600SN1	60ohm±25%	-	1700mA	Kit		≥1A		ReFlow
	0.5			BLM15PD800SN1	80ohm±25%	-	1500mA	Kit		≥1A		ReFlow
	0.5			BLM15PD121SN1	120ohm±25%	-	1300mA	Kit		≥1A		ReFlow
	0.5		For GHz Band Noise	For General Signal Lines	p77 BLM15HG601SN1	600ohm±25%	1000ohm±40%	300mA	Kit		GHz	ReFlow
	0.5				p77 BLM15HG102SN1	1000ohm±25%	1400ohm±40%	250mA	Kit		GHz	ReFlow
	0.5				p77 BLM15HD601SN1	600ohm±25%	1400ohm±40%	300mA	Kit		GHz	ReFlow
	0.5				p77 BLM15HD102SN1	1000ohm±25%	2000ohm±40%	250mA	Kit		GHz	ReFlow
	0.5			For High Speed Signal Lines (Sharp Impedance Curve)	BLM15HD182SN1	1800ohm±25%	2700ohm±40%	200mA	Kit		GHz	ReFlow
	0.5				BLM15HB121SN1	120ohm±25%	500ohm±40%	300mA	Kit		GHz	ReFlow
	0.5				BLM15HB221SN1	220ohm±25%	900ohm±40%	250mA	Kit		GHz	ReFlow
	0.5				Universal Type [Power Lines/Signal Lines]	p27 BLM15EG121SN1	120ohm±25%	145ohm(Typ.)	1500mA	Kit	≥1A	GHz
	0.5		For High-GHz Band Noise	For General Signal Lines	p83 BLM15GG221SN1	220ohm±25%	600ohm±40%	300mA	Kit		Hi-GHz	ReFlow
	0.5				p83 BLM15GG471SN1	470ohm±25%	1200ohm±40%	200mA	Kit		Hi-GHz	ReFlow
	0.5			For High Speed Signal Lines	p83 BLM15GA750SN1	75ohm±25%	1000ohm±40%	200mA	Kit		Hi-GHz	ReFlow
0.5	p83 BLM15GA750SN1	75ohm±25%			1000ohm±40%	200mA	Kit		Hi-GHz	ReFlow		
0603	0.8	For General Signal Lines	p52 BLM18AG121SN1	120ohm±25%	-	500mA	Kit			Flow	ReFlow	
	0.8		BLM18AG151SN1	150ohm±25%	-	500mA	Kit			Flow	ReFlow	
	0.8		BLM18AG221SN1	220ohm±25%	-	500mA	Kit			Flow	ReFlow	
	0.8		BLM18AG331SN1	330ohm±25%	-	500mA	Kit			Flow	ReFlow	
	0.8		BLM18AG471SN1	470ohm±25%	-	500mA	Kit			Flow	ReFlow	
	0.8		BLM18AG601SN1	600ohm±25%	-	500mA	Kit			Flow	ReFlow	
	0.8		BLM18AG102SN1	1000ohm±25%	-	400mA	Kit			Flow	ReFlow	
	0.6		p56	BLM18TG121TN1	120ohm±25%	-	200mA				Flow	ReFlow
	0.6			BLM18TG221TN1	220ohm±25%	-	200mA				Flow	ReFlow
	0.6			BLM18TG601TN1	600ohm±25%	-	200mA				Flow	ReFlow
0.6	BLM18TG102TN1	1000ohm±25%		-	100mA				Flow	ReFlow		

Continued on the following page.

△Note • Please read rating and △CAUTION (for storage, operating, rating, soldering, mounting and handling) in this catalog to prevent smoking and/or burning, etc.  
 • This catalog has only typical specifications because there is no space for detailed specifications. Therefore, please review our product specifications or consult the approval sheet for product specifications before ordering.

Size Code (Inch)	Thickness (mm)	Type	Part Number	Impedance		Rated Current	New	Kit	≥1A ≥3A	GHz Hz	Flow	ReFlow				
				at 100MHz/20°C	at 1GHz/20°C											
0603	0.8	For High Speed Signal Lines (Sharp Impedance Curve)	p63	BLM18BD470SN1	47ohm±25%	-		Kit			Flow	ReFlow				
	0.8			BLM18BD121SN1	120ohm±25%	-		Kit			Flow	ReFlow				
	0.8			BLM18BD151SN1	150ohm±25%	-		Kit			Flow	ReFlow				
	0.8			BLM18BD221SN1	220ohm±25%	-		Kit			Flow	ReFlow				
	0.8			BLM18BD331SN1	330ohm±25%	-		Kit			Flow	ReFlow				
	0.8			BLM18BD421SN1	420ohm±25%	-		Kit			Flow	ReFlow				
	0.8			BLM18BD471SN1	470ohm±25%	-		Kit			Flow	ReFlow				
	0.8			BLM18BD601SN1	600ohm±25%	-		Kit			Flow	ReFlow				
	0.8			BLM18BD102SN1	1000ohm±25%	-		Kit			Flow	ReFlow				
	0.8			BLM18BD152SN1	1500ohm±25%	-		Kit			Flow	ReFlow				
	0.8			BLM18BD182SN1	1800ohm±25%	-		Kit			Flow	ReFlow				
	0.8			BLM18BD222SN1	2200ohm±25%	-		Kit			Flow	ReFlow				
	0.8			BLM18BD252SN1	2500ohm±25%	-		Kit			Flow	ReFlow				
	0.8			BLM18BB050SN1	5ohm±25%	-		Kit			Flow	ReFlow				
	0.8			BLM18BB100SN1	10ohm±25%	-		Kit			Flow	ReFlow				
	0.8			BLM18BB220SN1	22ohm±25%	-		Kit			Flow	ReFlow				
	0.8			BLM18BB470SN1	47ohm±25%	-		Kit			Flow	ReFlow				
	0.8			BLM18BB600SN1	60ohm±25%	-		Kit			Flow	ReFlow				
	0.8			BLM18BB750SN1	75ohm±25%	-		Kit			Flow	ReFlow				
	0.8			BLM18BB121SN1	120ohm±25%	-		Kit			Flow	ReFlow				
	0.8			BLM18BB141SN1	140ohm±25%	-					Flow	ReFlow				
	0.8			BLM18BB151SN1	150ohm±25%	-		Kit			Flow	ReFlow				
	0.8			BLM18BB221SN1	220ohm±25%	-		Kit			Flow	ReFlow				
	0.8			BLM18BB331SN1	330ohm±25%	-		Kit			Flow	ReFlow				
	0.8			BLM18BB471SN1	470ohm±25%	-		Kit			Flow	ReFlow				
	0.8			BLM18BA050SN1	5ohm±25%	-		Kit			Flow	ReFlow				
	0.8			BLM18BA100SN1	10ohm±25%	-		Kit			Flow	ReFlow				
	0.8			BLM18BA220SN1	22ohm±25%	-					Flow	ReFlow				
	0.8			BLM18BA470SN1	47ohm±25%	-		Kit			Flow	ReFlow				
	0.8			BLM18BA750SN1	75ohm±25%	-		Kit			Flow	ReFlow				
	0.8			BLM18BA121SN1	120ohm±25%	-		Kit			Flow	ReFlow				
	0.8			For Digital Interface Lines	p70	BLM18RK121SN1	120ohm±25%	-		Kit			Flow	ReFlow		
	0.8					BLM18RK221SN1	220ohm±25%	-					Flow	ReFlow		
	0.8					BLM18RK471SN1	470ohm±25%	-		Kit			Flow	ReFlow		
	0.8					BLM18RK601SN1	600ohm±25%	-		Kit			Flow	ReFlow		
	0.8					BLM18RK102SN1	1000ohm±25%	-		Kit			Flow	ReFlow		
	0.8					Standard Type	p34	BLM18PG300SN1	30ohm(Typ.)	-		Kit	≥1A		Flow	ReFlow
	0.8							BLM18PG330SN1	33ohm±25%	-		Kit	≥3A		Flow	ReFlow
	0.8							BLM18PG600SN1	60ohm(Typ.)	-		Kit			Flow	ReFlow
	0.8							BLM18PG121SN1	120ohm±25%	-		Kit	≥1A		Flow	ReFlow
	0.8							BLM18PG181SN1	180ohm±25%	-		Kit	≥1A		Flow	ReFlow
	0.8							BLM18PG221SN1	220ohm±25%	-		Kit	≥1A		Flow	ReFlow
	0.8							BLM18PG331SN1	330ohm±25%	-		Kit	≥1A		Flow	ReFlow
	0.8			BLM18PG471SN1	470ohm±25%			-		Kit	≥1A		Flow	ReFlow		
	0.6			For Power Lines	p42			BLM18KG260TN1	26ohm±25%	-		Kit	≥3A		Flow	ReFlow
	0.6							BLM18KG300TN1	30ohm±25%	-		Kit	≥3A		Flow	ReFlow
	0.6							BLM18KG700TN1	70ohm±25%	-		Kit	≥3A		Flow	ReFlow
	0.6							BLM18KG101TN1	100ohm±25%	-		Kit	≥3A		Flow	ReFlow
0.6	BLM18KG121TN1	120ohm±25%	-				Kit	≥3A		Flow	ReFlow					
0.8	BLM18KG221SN1	220ohm±25%	-				Kit	≥1A		Flow	ReFlow					
0.8	BLM18KG331SN1	330ohm±25%	-				Kit	≥1A		Flow	ReFlow					
0.8	BLM18KG471SN1	470ohm±25%	-				Kit	≥1A		Flow	ReFlow					
0.8	BLM18KG601SN1	600ohm±25%	-				Kit	≥1A		Flow	ReFlow					
0.5	Low DC Resistance Type	p44	BLM18SG260TN1			26ohm±25%	-		Kit	≥3A		Flow	ReFlow			
0.5			BLM18SG700TN1			70ohm±25%	-		Kit	≥3A		Flow	ReFlow			
0.5			BLM18SG121TN1			120ohm±25%	-		Kit	≥3A		Flow	ReFlow			
0.5			BLM18SG221TN1	220ohm±25%	-		Kit	≥1A		Flow	ReFlow					
0.5	BLM18SG331TN1	330ohm±25%	-		Kit	≥1A		Flow	ReFlow							

Continued on the following page. ↗

△Note • Please read rating and △CAUTION (for storage, operating, rating, soldering, mounting and handling) in this catalog to prevent smoking and/or burning, etc.  
 • This catalog has only typical specifications because there is no space for detailed specifications. Therefore, please review our product specifications or consult the approval sheet for product specifications before ordering.



Size Code (Inch)	Thickness (mm)	Type	Part Number	Impedance		Rated Current	New	Kit	≥1A	≥3A	GHz	Flow	ReFlow
				at 100MHz/20°C	at 1GHz/20°C								
6063	0.8	For General Signal Lines	BLM18HG471SN1	470ohm±25%	600ohm(Typ.)	200mA		Kit			GHz	Flow	ReFlow
	0.8		BLM18HG601SN1	600ohm±25%	700ohm(Typ.)	200mA		Kit			GHz	Flow	ReFlow
	0.8		BLM18HG102SN1	1000ohm±25%	1000ohm(Typ.)	100mA		Kit			GHz	Flow	ReFlow
	0.8	For High Speed Signal Lines (Sharp Impedance Curve)	BLM18HE601SN1	600ohm±25%	600ohm(Typ.)	800mA		Kit			GHz	Flow	ReFlow
	0.8		BLM18HE102SN1	1000ohm±25%	1000ohm(Typ.)	600mA		Kit			GHz	Flow	ReFlow
	0.8		BLM18HE152SN1	1500ohm±25%	1500ohm(Typ.)	500mA		Kit			GHz	Flow	ReFlow
	0.8		BLM18HD471SN1	470ohm±25%	1000ohm(Typ.)	100mA		Kit			GHz	Flow	ReFlow
	0.8		BLM18HD601SN1	600ohm±25%	1200ohm(Typ.)	100mA		Kit			GHz	Flow	ReFlow
	0.8		BLM18HD102SN1	1000ohm±25%	1700ohm(Typ.)	50mA		Kit			GHz	Flow	ReFlow
	0.8		BLM18HB121SN1	120ohm±25%	500ohm±40%	200mA		Kit			GHz	Flow	ReFlow
	0.8		BLM18HB221SN1	220ohm±25%	1100ohm±40%	100mA		Kit			GHz	Flow	ReFlow
	0.8		BLM18HB331SN1	330ohm±25%	1600ohm±40%	50mA		Kit			GHz	Flow	ReFlow
	0.8		BLM18HK331SN1	330ohm±25%	400ohm±40%	200mA		Kit			GHz	Flow	ReFlow
	0.8	For Digital Interface Lines	BLM18HK471SN1	470ohm±25%	600ohm±40%	200mA		Kit			GHz	Flow	ReFlow
	0.8		BLM18HK601SN1	600ohm±25%	700ohm±40%	100mA		Kit			GHz	Flow	ReFlow
	0.8		BLM18HK102SN1	1000ohm±25%	1200ohm±40%	50mA		Kit			GHz	Flow	ReFlow
	0.5	Universal Type [Power lines/ Signal lines]	BLM18EG101TN1	100ohm±25%	140ohm(Typ.)	2000mA		Kit	≥1A		GHz	Flow	ReFlow
	0.8		BLM18EG121SN1	120ohm±25%	145ohm(Typ.)	2000mA		Kit	≥1A		GHz	Flow	ReFlow
	0.8		BLM18EG221SN1	220ohm±25%	260ohm(Typ.)	2000mA		Kit	≥1A		GHz	Flow	ReFlow
	0.5		BLM18EG221TN1	220ohm±25%	300ohm(Typ.)	1000mA		Kit	≥1A		GHz	Flow	ReFlow
0.5	BLM18EG331TN1		330ohm±25%	450ohm(Typ.)	500mA		Kit			GHz	Flow	ReFlow	
0.5	BLM18EG391TN1		390ohm±25%	520ohm(Typ.)	500mA		Kit			GHz	Flow	ReFlow	
0.8	BLM18EG471SN1		470ohm±25%	550ohm(Typ.)	500mA		Kit			GHz	Flow	ReFlow	
0.8	BLM18EG601SN1		600ohm±25%	700ohm(Typ.)	500mA		Kit			GHz	Flow	ReFlow	
0.8	For High-GHz Band Noise	BLM18GG471SN1	470ohm±25%	1800ohm±30%	200mA		Kit			GHz		ReFlow	
8085	0.85	For General Signal Lines	BLM21AG121SN1	120ohm±25%	-	200mA		Kit				Flow	ReFlow
	0.85		BLM21AG151SN1	150ohm±25%	-	200mA		Kit				Flow	ReFlow
	0.85		BLM21AG221SN1	220ohm±25%	-	200mA		Kit				Flow	ReFlow
	0.85		BLM21AG331SN1	330ohm±25%	-	200mA		Kit				Flow	ReFlow
	0.85		BLM21AG471SN1	470ohm±25%	-	200mA		Kit				Flow	ReFlow
	0.85		BLM21AG601SN1	600ohm±25%	-	200mA		Kit				Flow	ReFlow
	0.85		BLM21AG102SN1	1000ohm±25%	-	200mA		Kit				Flow	ReFlow
	0.85		BLM21BD121SN1	120ohm±25%	-	200mA		Kit				Flow	ReFlow
	0.85	For High Speed Signal Lines (Sharp Impedance Curve)	BLM21BD151SN1	150ohm±25%	-	200mA						Flow	ReFlow
	0.85		BLM21BD221SN1	220ohm±25%	-	200mA		Kit				Flow	ReFlow
	0.85		BLM21BD331SN1	330ohm±25%	-	200mA						Flow	ReFlow
	0.85		BLM21BD421SN1	420ohm±25%	-	200mA		Kit				Flow	ReFlow
	0.85		BLM21BD471SN1	470ohm±25%	-	200mA		Kit				Flow	ReFlow
	0.85		BLM21BD601SN1	600ohm±25%	-	200mA		Kit				Flow	ReFlow
	0.85		BLM21BD751SN1	750ohm±25%	-	200mA						Flow	ReFlow
	0.85		BLM21BD102SN1	1000ohm±25%	-	200mA		Kit				Flow	ReFlow
	0.85		BLM21BD152SN1	1500ohm±25%	-	200mA		Kit				Flow	ReFlow
	0.85		BLM21BD182SN1	1800ohm±25%	-	200mA		Kit				Flow	ReFlow
	0.85		BLM21BD222TN1	2200ohm±25%	-	200mA		Kit				Flow	ReFlow
	1.25		BLM21BD222SN1	2250ohm(Typ.)	-	200mA		Kit				Flow	ReFlow
	1.25		BLM21BD272SN1	2700ohm±25%	-	200mA		Kit				Flow	ReFlow
	0.85		BLM21BB050SN1	5ohm±25%	-	500mA		Kit				Flow	ReFlow
	0.85	BLM21BB600SN1	60ohm±25%	-	200mA		Kit				Flow	ReFlow	
	0.85	BLM21BB750SN1	75ohm±25%	-	200mA		Kit				Flow	ReFlow	
	0.85	BLM21BB121SN1	120ohm±25%	-	200mA		Kit				Flow	ReFlow	
	0.85	BLM21BB151SN1	150ohm±25%	-	200mA						Flow	ReFlow	
	0.85	BLM21BB201SN1	200ohm±25%	-	200mA						Flow	ReFlow	
	0.85	BLM21BB221SN1	220ohm±25%	-	200mA		Kit				Flow	ReFlow	
	0.85	BLM21BB331SN1	330ohm±25%	-	200mA		Kit				Flow	ReFlow	
	0.85	BLM21BB471SN1	470ohm±25%	-	200mA		Kit				Flow	ReFlow	
	0.85	For Digital Interface Lines	BLM21RK121SN1	120ohm±25%	-	200mA						Flow	ReFlow
	0.85		BLM21RK221SN1	220ohm±25%	-	200mA						Flow	ReFlow
0.85	BLM21RK471SN1		470ohm±25%	-	200mA						Flow	ReFlow	
0.85	BLM21RK601SN1		600ohm±25%	-	200mA						Flow	ReFlow	
0.85	BLM21RK102SN1		1000ohm±25%	-	200mA						Flow	ReFlow	

Continued on the following page.

△Note • Please read rating and △CAUTION (for storage, operating, rating, soldering, mounting and handling) in this catalog to prevent smoking and/or burning, etc.  
 • This catalog has only typical specifications because there is no space for detailed specifications. Therefore, please review our product specifications or consult the approval sheet for product specifications before ordering.

Size Code (Inch)	Thickness (mm)	Type	Part Number	Impedance		Rated Current	New	Kit	≥1A	GHz	Flow	ReFlow	
				at 100MHz/20°C	at 1GHz/20°C								
0805	0.85	For Power Lines	p36 BLM21PG220SN1	22ohm±25%	-	6000mA		Kit	≥3A		Flow	ReFlow	
	0.85		BLM21PG300SN1	30ohm(Typ.)	-	3000mA		Kit	≥3A		Flow	ReFlow	
	0.85		BLM21PG600SN1	60ohm±25%	-	3000mA		Kit	≥3A		Flow	ReFlow	
	0.85		BLM21PG121SN1	120ohm±25%	-	3000mA		Kit	≥3A		Flow	ReFlow	
	0.85		BLM21PG221SN1	220ohm±25%	-	2000mA		Kit	≥1A		Flow	ReFlow	
	0.85		BLM21PG331SN1	330ohm±25%	-	1500mA		Kit	≥1A		Flow	ReFlow	
1206	1.1	For Power Lines	p38 BLM31PG330SN1	33ohm±25%	-	6000mA		Kit	≥3A		Flow	ReFlow	
	1.1		BLM31PG500SN1	50ohm(Typ.)	-	3000mA		Kit	≥3A		Flow	ReFlow	
	1.1		BLM31PG121SN1	120ohm±25%	-	3000mA		Kit	≥3A		Flow	ReFlow	
	1.1		BLM31PG391SN1	390ohm±25%	-	2000mA		Kit	≥1A		Flow	ReFlow	
	1.1		BLM31PG601SN1	600ohm±25%	-	1500mA		Kit	≥1A		Flow	ReFlow	
1806	1.6	For Power Lines	p40 BLM41PG600SN1	60ohm(Typ.)	-	6000mA		Kit	≥3A		Flow	ReFlow	
	1.6		BLM41PG750SN1	75ohm(Typ.)	-	3000mA		Kit	≥3A		Flow	ReFlow	
	1.6		BLM41PG181SN1	180ohm±25%	-	3000mA		Kit	≥3A		Flow	ReFlow	
	1.6		BLM41PG471SN1	470ohm±25%	-	2000mA		Kit	≥1A		Flow	ReFlow	
	1.6		BLM41PG102SN1	1000ohm±25%	-	1500mA		Kit	≥1A		Flow	ReFlow	
0804	0.5	For General Signal Lines	p85 BLA2AAG121SN4	120ohm±25%	-	100mA						ReFlow	
	0.5		BLA2AAG221SN4	220ohm±25%	-	50mA						ReFlow	
	0.5		BLA2AAG601SN4	600ohm±25%	-	50mA						ReFlow	
	0.5		BLA2AAG102SN4	1000ohm±25%	-	50mA						ReFlow	
	0.5	For High Speed Signal Lines	p85 BLA2ABB100SN4	10ohm±25%	-	200mA							ReFlow
	0.5		BLA2ABB220SN4	22ohm±25%	-	200mA							ReFlow
	0.5		BLA2ABB470SN4	47ohm±25%	-	200mA							ReFlow
	0.5		BLA2ABB121SN4	120ohm±25%	-	50mA							ReFlow
	0.5		BLA2ABB221SN4	220ohm±25%	-	50mA							ReFlow
	0.5		BLA2ABD750SN4	75ohm±25%	-	200mA							ReFlow
	0.5		BLA2ABD121SN4	120ohm±25%	-	200mA							ReFlow
	0.5		BLA2ABD221SN4	220ohm±25%	-	100mA							ReFlow
	0.5		BLA2ABD471SN4	470ohm±25%	-	100mA							ReFlow
	0.5		BLA2ABD601SN4	600ohm±25%	-	100mA							ReFlow
0.5	BLA2ABD102SN4	1000ohm±25%	-	50mA							ReFlow		
1206	0.8	For General Signal Lines	p88 BLA31AG300SN4	30ohm±25%	-	200mA					Flow	ReFlow	
	0.8		BLA31AG600SN4	60ohm±25%	-	200mA					Flow	ReFlow	
	0.8		BLA31AG121SN4	120ohm±25%	-	150mA					Flow	ReFlow	
	0.8		BLA31AG221SN4	220ohm±25%	-	150mA					Flow	ReFlow	
	0.8		BLA31AG601SN4	600ohm±25%	-	100mA					Flow	ReFlow	
	0.8	BLA31AG102SN4	1000ohm±25%	-	50mA					Flow	ReFlow		
	0.8	For High Speed Signal Lines	p88 BLA31BD121SN4	120ohm±25%	-	150mA					Flow	ReFlow	
	0.8		BLA31BD221SN4	220ohm±25%	-	150mA					Flow	ReFlow	
	0.8		BLA31BD471SN4	470ohm±25%	-	100mA					Flow	ReFlow	
	0.8		BLA31BD601SN4	600ohm±25%	-	100mA					Flow	ReFlow	
0.8	BLA31BD102SN4		1000ohm±25%	-	50mA					Flow	ReFlow		

△Note • Please read rating and △CAUTION (for storage, operating, rating, soldering, mounting and handling) in this catalog to prevent smoking and/or burning, etc.  
 • This catalog has only typical specifications because there is no space for detailed specifications. Therefore, please review our product specifications or consult the approval sheet for product specifications before ordering.

# BLM03AX Series (0201 Size)



High Spec Ferrite Bead Ultra low dc resistance and wide impedance line up. Fit for both power lines and signal lines.

Chip Ferrite Bead Universal Type [Power Lines/Signal Lines]

### ■ Dimensions

(in mm)

### ■ Equivalent Circuit

(Resistance element becomes dominant at high frequencies.)

### ■ Packaging

Code	Packaging	Minimum Quantity
D	180mm Reel Paper Tape	15000
J	330mm Reel Paper Tape	50000
B	Bulk(Bag)	1000

Refer to pages from p.91 to p.94 for mounting information.

### ■ Rated Value (□: packaging code)

Part Number	Impedance (at 100MHz/20°C)	Rated Current	DC Resistance	Operating Temperature Range	
BLM03AX100SN1□	10ohm(Typ.)	1000mA	0.05ohm max.	-55°C to +125°C	Kit $\geq 1A$
BLM03AX800SN1□	80ohm±25%	500mA	0.18ohm max.	-55°C to +125°C	Kit
BLM03AX121SN1□	120ohm±25%	450mA	0.23ohm max.	-55°C to +125°C	Kit
BLM03AX241SN1□	240ohm±25%	350mA	0.38ohm max.	-55°C to +125°C	Kit
BLM03AX601SN1□	600ohm±25%	250mA	0.85ohm max.	-55°C to +125°C	Kit
BLM03AX102SN1□	1000ohm±25%	200mA	1.25ohm max.	-55°C to +125°C	Kit

Number of Circuits: 1

### ■ Impedance-Frequency Characteristics (Main Items)

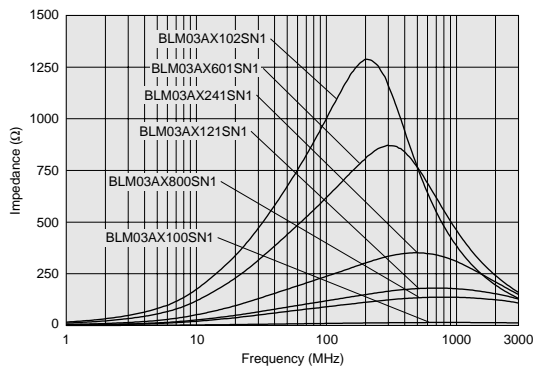

### ■ Impedance-Frequency Characteristics

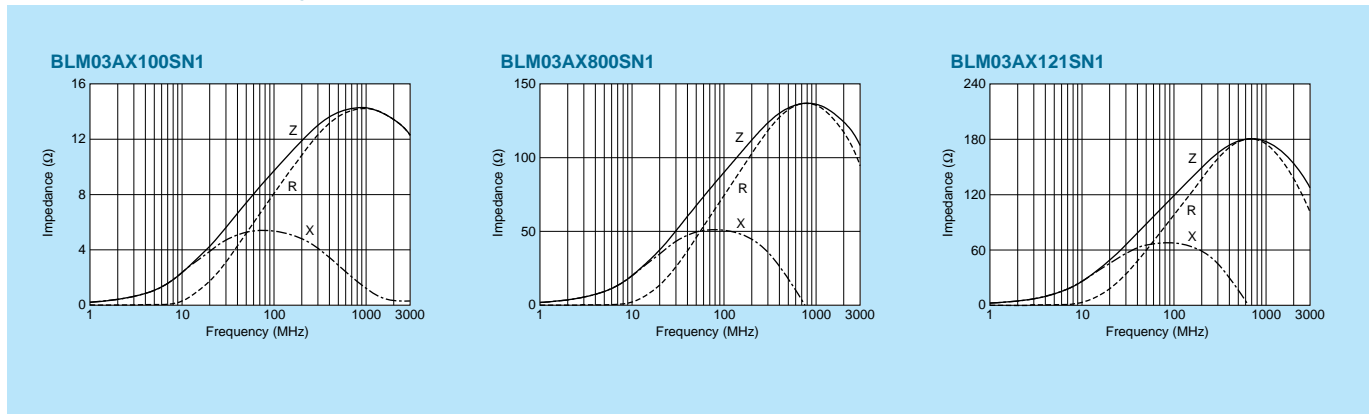

Continued on the following page.

△Note • Please read rating and △CAUTION (for storage, operating, rating, soldering, mounting and handling) in this catalog to prevent smoking and/or burning, etc.  
 • This catalog has only typical specifications because there is no space for detailed specifications. Therefore, please review our product specifications or consult the approval sheet for product specifications before ordering.

Chip EMIFIL®

Chip Common Mode Choke Coil

Block Type EMIFIL®

Impedance-Frequency Characteristics

BLM03AX241SN1

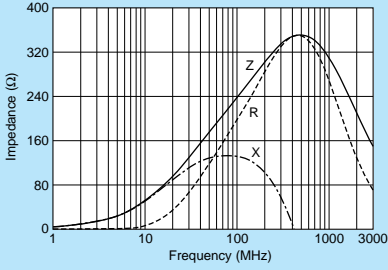

BLM03AX601SN1

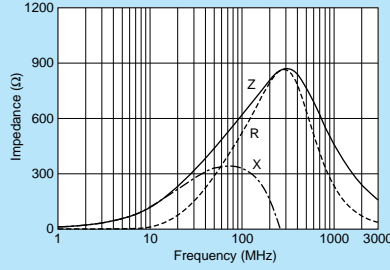

BLM03AX102SN1

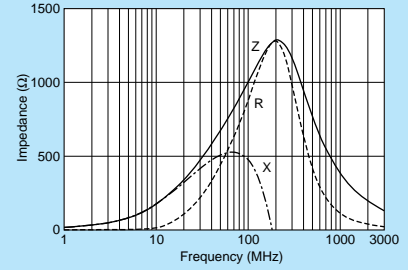

Universal Type [Power Lines/Signal Lines] Chip Ferrite Bead

Chip EMIFIL®

Chip Common Mode Choke Coil

Block Type EMIFIL®

△Note • Please read rating and △CAUTION (for storage, operating, rating, soldering, mounting and handling) in this catalog to prevent smoking and/or burning, etc.  
 • This catalog has only typical specifications because there is no space for detailed specifications. Therefore, please review our product specifications or consult the approval sheet for product specifications before ordering.

# BLM15AX Series (0402 Size)



High Spec Ferrite Bead Ultra low dc resistance and wide impedance line up. Fit for both power lines and signal lines.

Chip Ferrite Bead  
Universal Type [Power Lines/Signal Lines]

### ■ Dimensions

(in mm)

### ■ Equivalent Circuit

(Resistance element becomes dominant at high frequencies.)

### ■ Packaging

Code	Packaging	Minimum Quantity
D	180mm Reel Paper Tape	10000
J	330mm Reel Paper Tape	50000
B	Bulk(Bag)	1000

Refer to pages from p.91 to p.94 for mounting information.

### ■ Rated Value (□: packaging code)

Part Number	Impedance (at 100MHz/20°C)	Rated Current	DC Resistance	Operating Temperature Range	
BLM15AX100SN1□	10ohm(Typ.)	1740mA	0.015ohm max.	-55°C to +125°C	Kit ≥1A
BLM15AX300SN1□	30ohm±25%	1100mA	0.06ohm max.	-55°C to +125°C	New Kit ≥1A
BLM15AX700SN1□	70ohm±25%	780mA	0.1ohm max.	-55°C to +125°C	Kit
BLM15AX121SN1□	120ohm±25%	680mA	0.13ohm max.	-55°C to +125°C	Kit
BLM15AX221SN1□	220ohm±25%	580mA	0.18ohm max.	-55°C to +125°C	Kit
BLM15AX601SN1□	600ohm±25%	420mA	0.34ohm max.	-55°C to +125°C	Kit
BLM15AX102SN1□	1000ohm±25%	350mA	0.49ohm max.	-55°C to +125°C	Kit

Number of Circuits: 1

### ■ Impedance-Frequency Characteristics (Main Items)

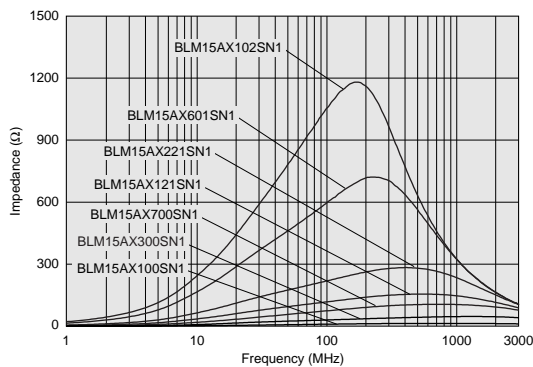

Continued on the following page.

Chip Common Mode Choke Coil

Block Type EMI/FIL

△Note • Please read rating and △CAUTION (for storage, operating, rating, soldering, mounting and handling) in this catalog to prevent smoking and/or burning, etc.  
• This catalog has only typical specifications because there is no space for detailed specifications. Therefore, please review our product specifications or consult the approval sheet for product specifications before ordering.

Impedance-Frequency Characteristics

BLM15AX100SN1

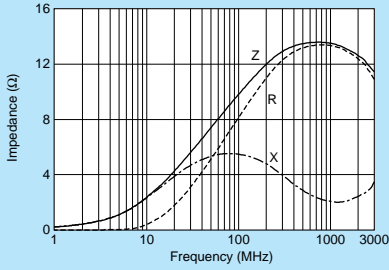

BLM15AX300SN1

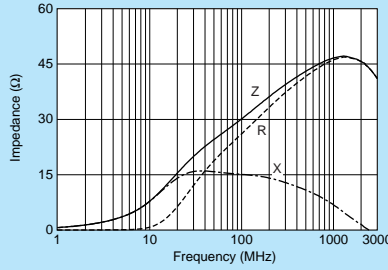

BLM15AX700SN1

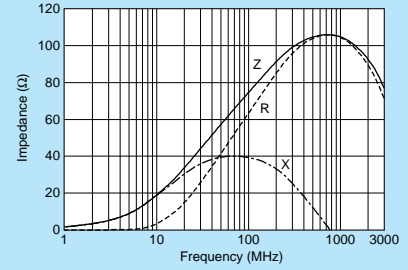

BLM15AX121SN1

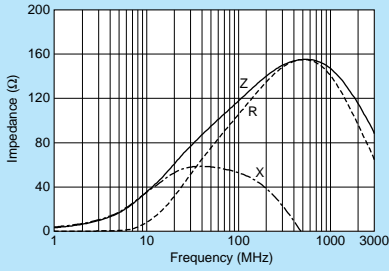

BLM15AX221SN1

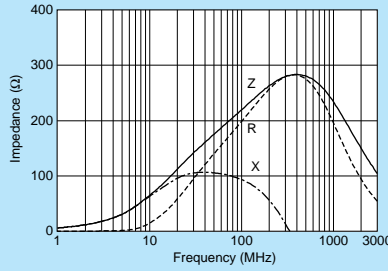

BLM15AX601SN1

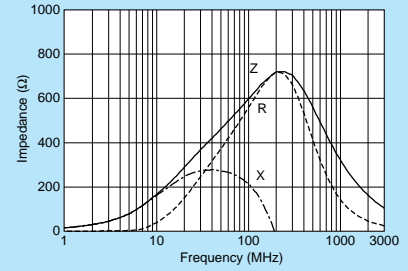

BLM15AX102SN1

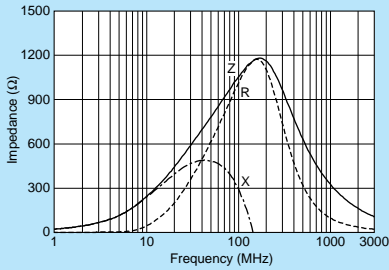

Universal Type [Power Lines/Signal Lines] Chip Ferrite Bead

Chip EMIFIL®

Chip Common Mode Choke Coil

Block Type EMIFIL®

⚠Note • Please read rating and ⚠CAUTION (for storage, operating, rating, soldering, mounting and handling) in this catalog to prevent smoking and/or burning, etc.  
 • This catalog has only typical specifications because there is no space for detailed specifications. Therefore, please review our product specifications or consult the approval sheet for product specifications before ordering.

Excellent for Both of Signal and Power Lines!  
Multi Function Chip Ferrite Bead BLM□□AX Series

Feature

- 1/2 DC resistance than conventional type by latest technology
  - New ferrite material
  - Optimum ferrite firing condition
  - Fine piling technology
  - Advanced coil pattern design technology
- Improved stability of performance at heat shock
- Wide line-up from 10 to 1000ohm(@100MHz) useful for signal line

Advantage

- High Rated Current
  - Good for Miniaturize of high power equipment
- Lower Voltage down at Ferrite bead
  - Good for Battery driven equipment by saving running voltage margin
- Higher Reliability

Drastically Reduced DC Resistance

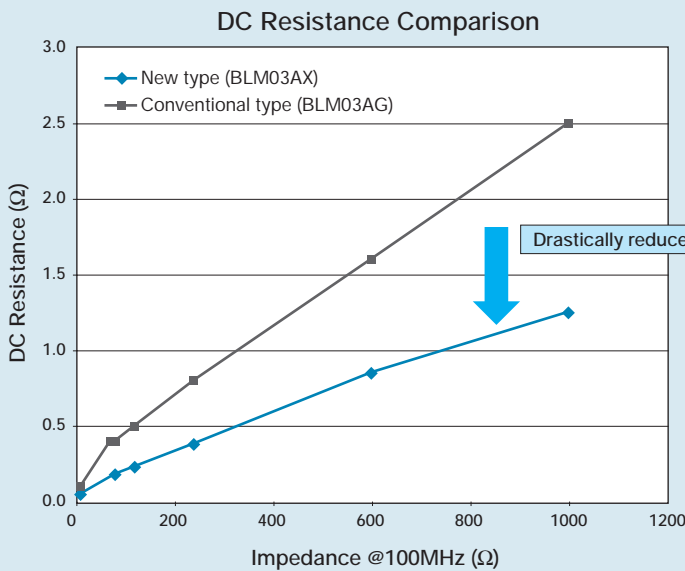

Test Result - Heat Shock

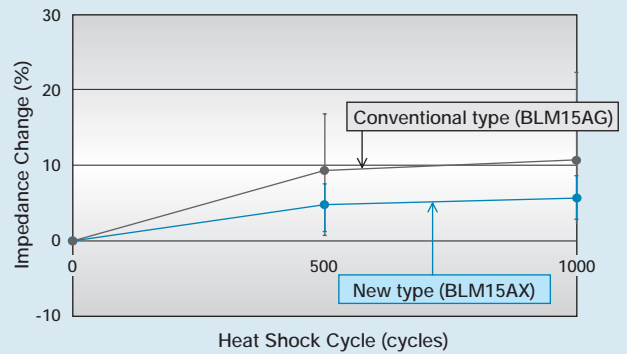

△Note • Please read rating and △CAUTION (for storage, operating, rating, soldering, mounting and handling) in this catalog to prevent smoking and/or burning, etc.  
• This catalog has only typical specifications because there is no space for detailed specifications. Therefore, please review our product specifications or consult the approval sheet for product specifications before ordering.

# BLM15E Series (0402 Size)



For GHz band noise, also capable to large current.

### ■ Dimensions

(in mm)

### ■ Equivalent Circuit

(Resistance element becomes dominant at high frequencies.)

### ■ Packaging

Code	Packaging	Minimum Quantity
D	180mm Reel Paper Tape	10000
J	330mm Reel Paper Tape	50000
B	Bulk(Bag)	1000

Refer to pages from p.91 to p.94 for mounting information.

### ■ Rated Value (□: packaging code)

Part Number	Impedance (at 100MHz/20°C)	Impedance (at 1GHz/20°C)	Rated Current	DC Resistance	Operating Temperature Range	Kit
BLM15EG121SN1□	120ohm±25%	145ohm(Typ.)	1500mA	0.095ohm max.	-55°C to +125°C	Kit $\geq 1A$
BLM15EG221SN1□	220ohm±25%	270ohm(Typ.)	700mA	0.28ohm max.	-55°C to +125°C	Kit

Number of Circuits: 1

### ■ Impedance-Frequency Characteristics (Main Items)

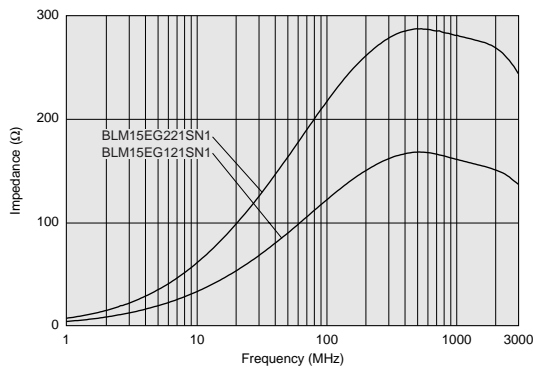

### ■ Notice (Rating)

In operating temperature exceeding +85°C, derating of current is necessary for BLM15E series. Please apply the derating curve shown in chart according to the operating temperature.

#### Derating

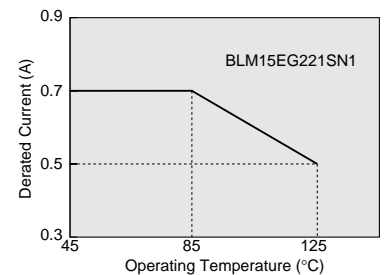
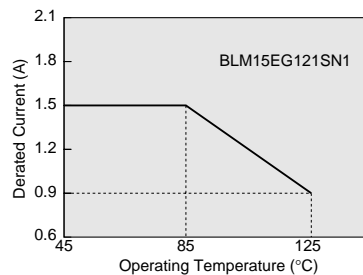

### ■ Impedance-Frequency Characteristics

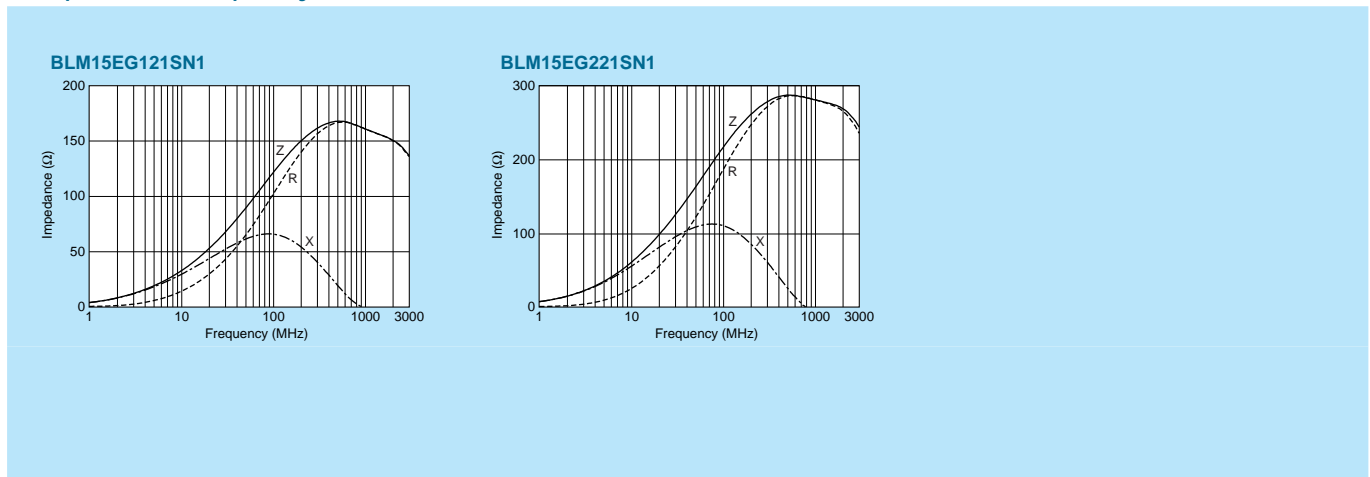

⚠Note • Please read rating and ⚠CAUTION (for storage, operating, rating, soldering, mounting and handling) in this catalog to prevent smoking and/or burning, etc.  
 • This catalog has only typical specifications because there is no space for detailed specifications. Therefore, please review our product specifications or consult the approval sheet for product specifications before ordering.



# BLM18E Series (0603 Size)



For GHz band noise, also capable to large current.



### ■ Dimensions

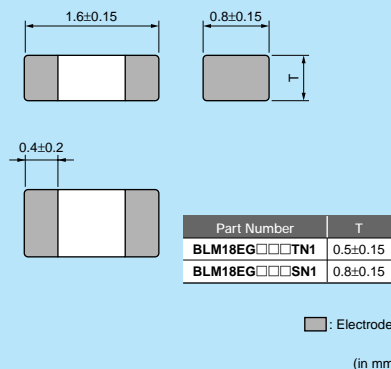

### ■ Equivalent Circuit

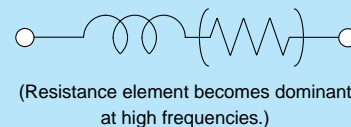

### ■ Packaging

Code	Packaging	Minimum Quantity
D	180mm Reel Paper Tape	4000
J	330mm Reel Paper Tape	10000
B	Bulk(Bag)	1000

Refer to pages from p.91 to p.94 for mounting information.

### ■ Rated Value (□: packaging code)

Part Number	Impedance (at 100MHz/20°C)	Impedance (at 1GHz/20°C)	Rated Current	DC Resistance	Operating Temperature Range	Kit
BLM18EG101TN1□	100ohm±25%	140ohm(Typ.)	2000mA	0.045ohm max.	-55°C to +125°C	Kit ≥1A
BLM18EG121SN1□	120ohm±25%	145ohm(Typ.)	2000mA	0.04ohm max.	-55°C to +125°C	Kit ≥1A
BLM18EG221SN1□	220ohm±25%	260ohm(Typ.)	2000mA	0.05ohm max.	-55°C to +125°C	Kit ≥1A
BLM18EG221TN1□	220ohm±25%	300ohm(Typ.)	1000mA	0.15ohm max.	-55°C to +125°C	Kit ≥1A
BLM18EG331TN1□	330ohm±25%	450ohm(Typ.)	500mA	0.21ohm max.	-55°C to +125°C	Kit
BLM18EG391TN1□	390ohm±25%	520ohm(Typ.)	500mA	0.3ohm max.	-55°C to +125°C	Kit
BLM18EG471SN1□	470ohm±25%	550ohm(Typ.)	500mA	0.21ohm max.	-55°C to +125°C	Kit
BLM18EG601SN1□	600ohm±25%	700ohm(Typ.)	500mA	0.35ohm max.	-55°C to +125°C	Kit

Number of Circuits: 1

### ■ Impedance-Frequency Characteristics (Main Items)

#### BLM18EG\_TN Series

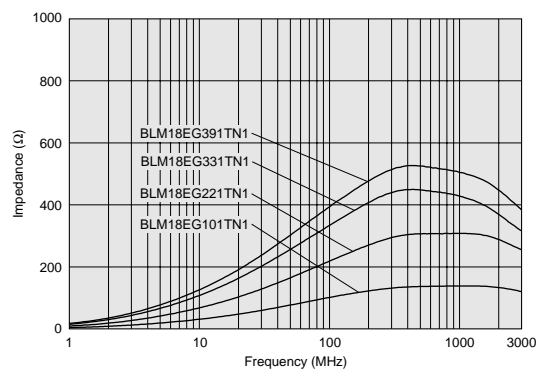

#### BLM18EG\_SN Series

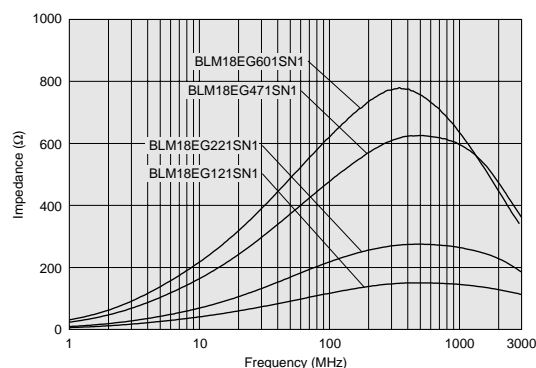

### ■ Notice (Rating)

In operating temperature exceeding +85°C, derating of current is necessary for BLM18EG series. Please apply the derating curve shown in chart according to the operating temperature.

#### Derating

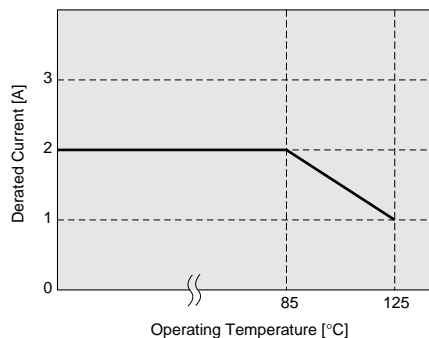

Continued on the following page. ↗

△Note • Please read rating and △CAUTION (for storage, operating, rating, soldering, mounting and handling) in this catalog to prevent smoking and/or burning, etc.  
• This catalog has only typical specifications because there is no space for detailed specifications. Therefore, please review our product specifications or consult the approval sheet for product specifications before ordering.

Impedance-Frequency Characteristics

BLM18EG101TN1

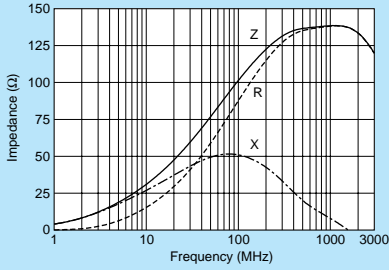

BLM18EG121SN1

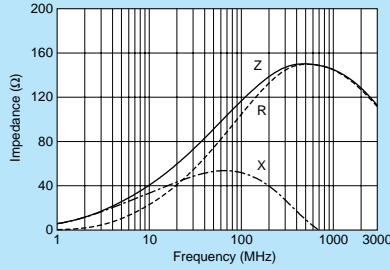

BLM18EG221SN1

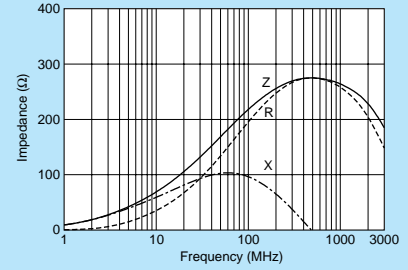

BLM18EG221TN1

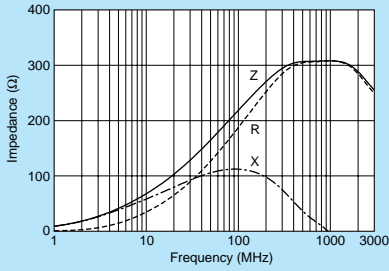

BLM18EG331TN1

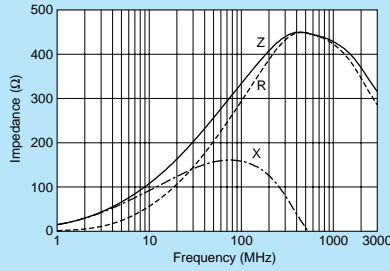

BLM18EG391TN1

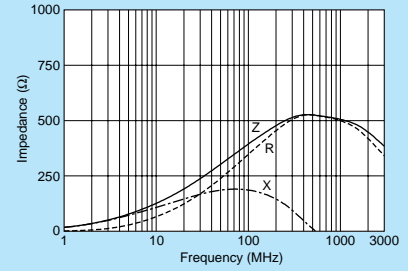

BLM18EG471SN1

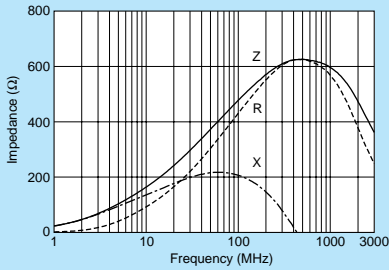

BLM18EG601SN1

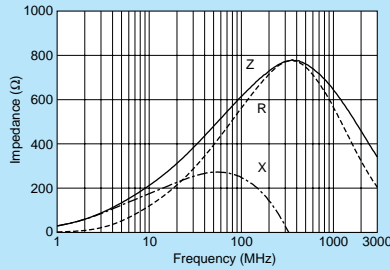

Note • Please read rating and CAUTION (for storage, operating, rating, soldering, mounting and handling) in this catalog to prevent smoking and/or burning, etc.  
 • This catalog has only typical specifications because there is no space for detailed specifications. Therefore, please review our product specifications or consult the approval sheet for product specifications before ordering.

# BLM03P Series (0201 Size)



## 0201 size for power lines.

\*Please refer to the products which are designed for both power lines and signal lines.

Chip Ferrite Bead  
Power Lines Type

Chip EMIFIL®

Chip Common Mode Choke Coil

Block Type EMIFIL®



### ■ Dimensions

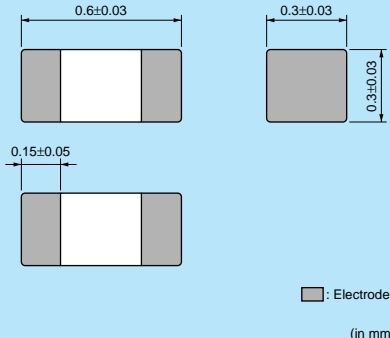

### ■ Equivalent Circuit



(Resistance element becomes dominant at high frequencies.)

### ■ Packaging

Code	Packaging	Minimum Quantity
D	180mm Reel Paper Tape	15000
J	330mm Reel Paper Tape	50000
B	Bulk(Bag)	1000

Refer to pages from p.91 to p.94 for mounting information.

### ■ Rated Value (□: packaging code)

Part Number	Impedance (at 100MHz/20°C)	Rated Current	DC Resistance	Operating Temperature Range	
BLM03PG220SN1□	22ohm±25%	900mA	0.065ohm max.	-55°C to +125°C	<b>Kit</b>
BLM03PG330SN1□	33ohm±25%	750mA	0.090ohm max.	-55°C to +125°C	<b>Kit</b>

Number of Circuits: 1

### ■ Impedance-Frequency Characteristics (Main Items)

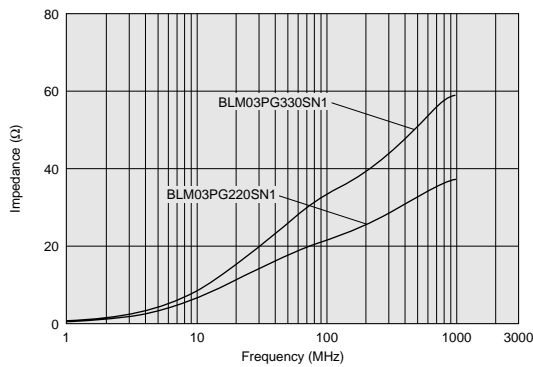

### ■ Impedance-Frequency Characteristics

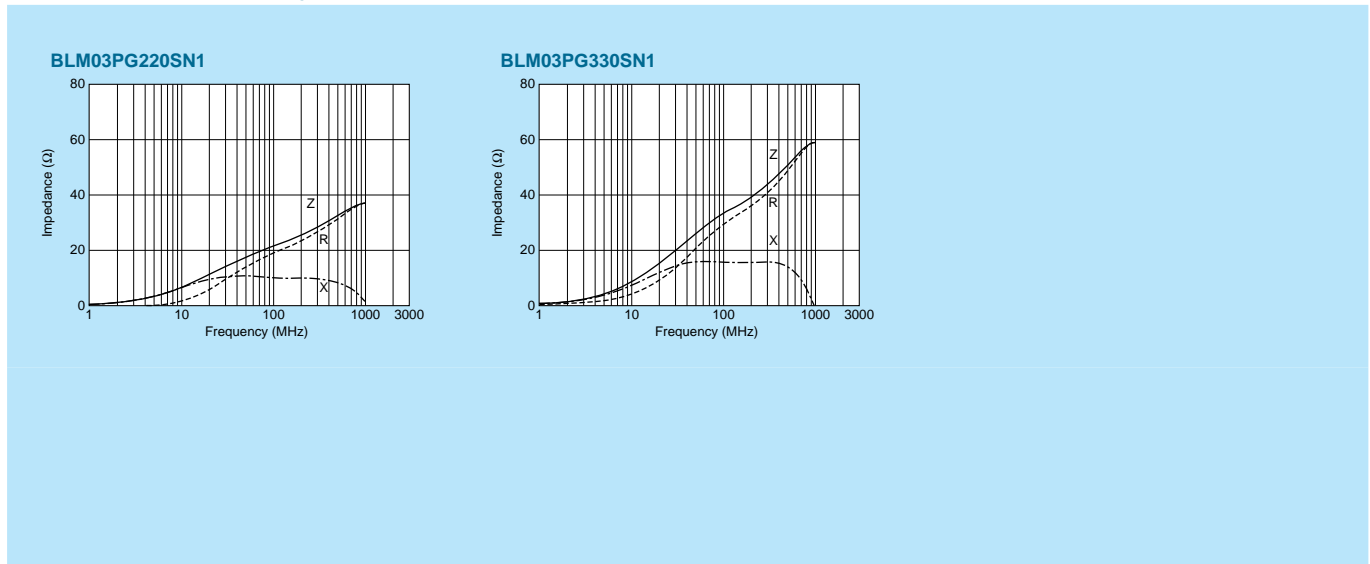

△Note • Please read rating and △CAUTION (for storage, operating, rating, soldering, mounting and handling) in this catalog to prevent smoking and/or burning, etc.  
• This catalog has only typical specifications because there is no space for detailed specifications. Therefore, please review our product specifications or consult the approval sheet for product specifications before ordering.

# BLM15PX Series (0402 Size)



## Improved DC resistance, meet larger current.

\*Please refer to the products which are designed for both power lines and signal lines.

### ■ Dimensions

(in mm)

### ■ Equivalent Circuit

(Resistance element becomes dominant at high frequencies.)

### ■ Packaging

Code	Packaging	Minimum Quantity
D	180mm Reel Paper Tape	10000
J	330mm Reel Paper Tape	50000
B	Bulk(Bag)	1000

Refer to pages from p.91 to p.94 for mounting information.

### ■ Rated Value (□: packaging code)

Part Number	Impedance (at 100MHz/20°C)	Rated Current	DC Resistance	Operating Temperature Range	
<b>BLM15PX121SN1</b> □	120ohm±25%	1800mA	0.06ohm max.	-55°C to +125°C	<b>New</b> <b>Kit</b> <b>≥1A</b>

Number of Circuits: 1

### ■ Impedance-Frequency Characteristics (Main Items)

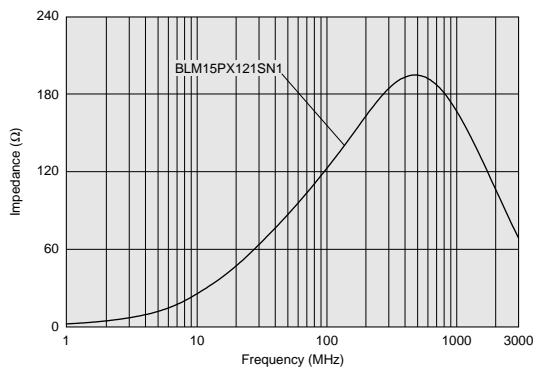

### ■ Notice (Rating)

In operating temperature exceeding +85°C, derating of current is necessary for BLM15PX series.

Please apply the derating curve shown in chart according to the operating temperature.

#### Derating

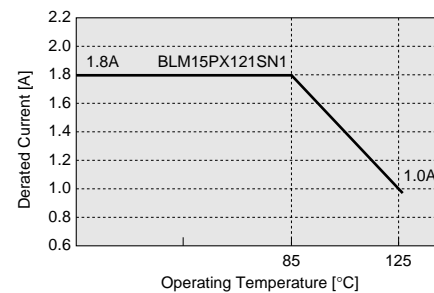

### ■ Impedance-Frequency Characteristics

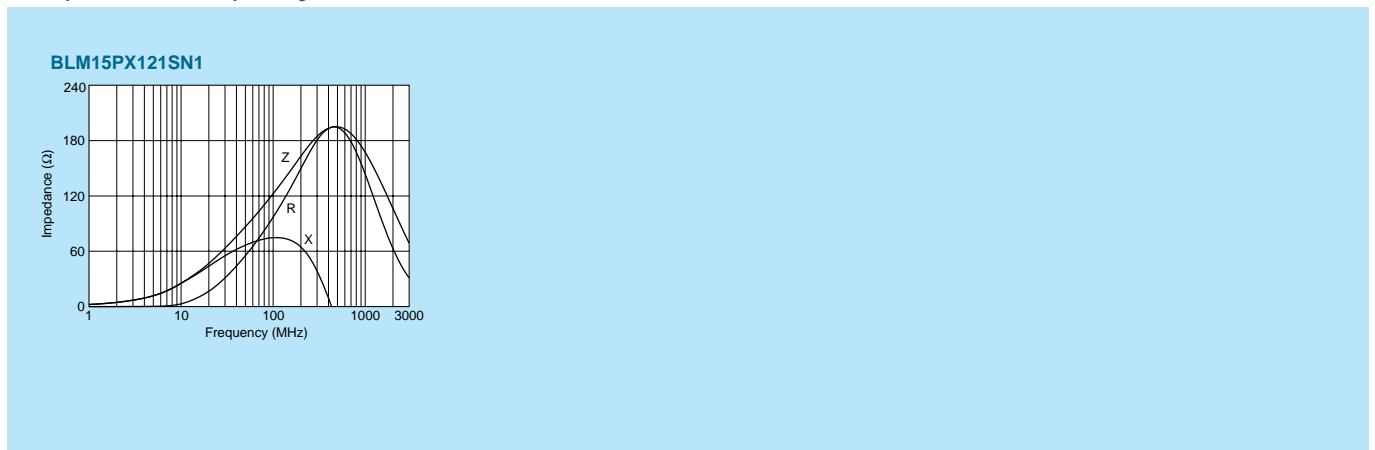

△Note • Please read rating and △CAUTION (for storage, operating, rating, soldering, mounting and handling) in this catalog to prevent smoking and/or burning, etc.  
 • This catalog has only typical specifications because there is no space for detailed specifications. Therefore, please review our product specifications or consult the approval sheet for product specifications before ordering.

# BLM15PG/BLM15PD Series (0402 Size)



## 0402 size for power lines.

\*Please refer to the products which are designed for both power lines and signal lines.

Chip Ferrite Bead  
Power Lines Type

Chip EMIFIL®

Chip Common Mode Choke Coil

Block Type EMIFIL®

### ■ Dimensions

(in mm)

### ■ Equivalent Circuit

(Resistance element becomes dominant at high frequencies.)

### ■ Packaging

Code	Packaging	Minimum Quantity
D	180mm Reel Paper Tape	10000
J	330mm Reel Paper Tape	50000
B	Bulk(Bag)	1000

Refer to pages from p.91 to p.94 for mounting information.

### ■ Rated Value (□: packaging code)

Part Number	Impedance (at 100MHz/20°C)	Rated Current	DC Resistance	Operating Temperature Range	
BLM15PG100SN1□	10ohm(Typ.)	1000mA	0.05ohm max.	-55°C to +125°C	Kit ≥1A
BLM15PD300SN1□	30ohm±25%	2200mA	0.035ohm max.	-55°C to +125°C	Kit ≥1A
BLM15PD600SN1□	60ohm±25%	1700mA	0.06ohm max.	-55°C to +125°C	Kit ≥1A
BLM15PD800SN1□	80ohm±25%	1500mA	0.07ohm max.	-55°C to +125°C	Kit ≥1A
BLM15PD121SN1□	120ohm±25%	1300mA	0.09ohm max.	-55°C to +125°C	Kit ≥1A

Number of Circuits: 1

### ■ Impedance-Frequency Characteristics (Main Items)

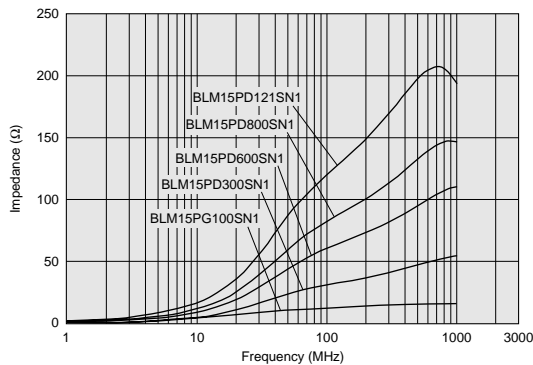

### ■ Notice (Rating)

In operating temperature exceeding +85°C, derating of current is necessary for BLM15PD series.

Please apply the derating curve shown in chart according to the operating temperature.

#### Derating

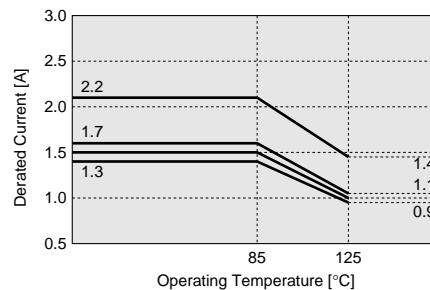

Continued on the following page. ↗

△Note • Please read rating and △CAUTION (for storage, operating, rating, soldering, mounting and handling) in this catalog to prevent smoking and/or burning, etc.  
• This catalog has only typical specifications because there is no space for detailed specifications. Therefore, please review our product specifications or consult the approval sheet for product specifications before ordering.

Impedance-Frequency Characteristics

BLM15PG100SN1

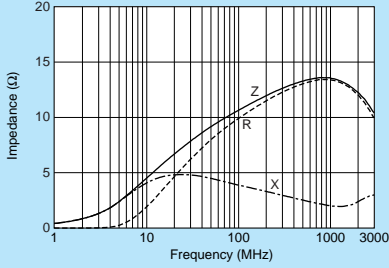

BLM15PD300SN1

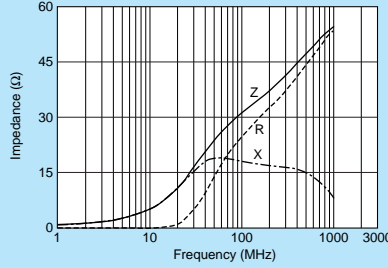

BLM15PD600SN1

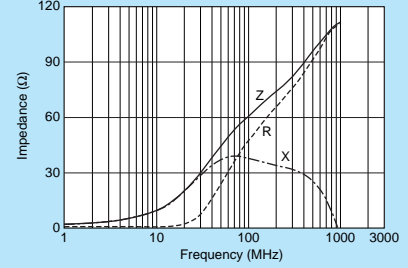

BLM15PD800SN1

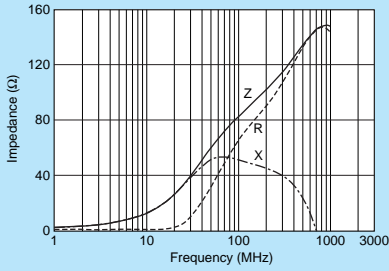

BLM15PD121SN1

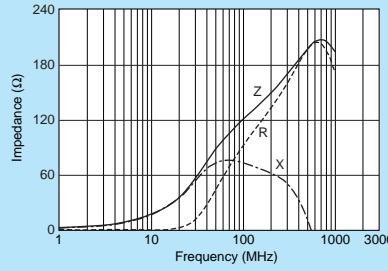

Power Lines Type  
Chip Ferrite Bead

Chip EMIFIL®

Chip Common Mode Choke Coil

Block Type EMIFIL®

⚠Note • Please read rating and ⚠CAUTION (for storage, operating, rating, soldering, mounting and handling) in this catalog to prevent smoking and/or burning, etc.  
 • This catalog has only typical specifications because there is no space for detailed specifications. Therefore, please review our product specifications or consult the approval sheet for product specifications before ordering.

# BLM18P Series (0603 Size)



## 0603 size for power lines.

\*Please refer to the products which are designed for both power lines and signal lines.

Chip Ferrite Bead Power Lines Type

### ■ Dimensions

(in mm)

### ■ Equivalent Circuit

(Resistance element becomes dominant at high frequencies.)

### ■ Packaging

Code	Packaging	Minimum Quantity
D	180mm Reel Paper Tape	4000
J	330mm Reel Paper Tape	10000
B	Bulk(Bag)	1000

Refer to pages from p.91 to p.94 for mounting information.

### ■ Rated Value (□: packaging code)

Part Number	Impedance (at 100MHz/20°C)	Rated Current	DC Resistance	Operating Temperature Range	
BLM18PG300SN1□	30ohm(Typ.)	1000mA	0.05ohm max.	-55°C to +125°C	Kit ≥1A
BLM18PG330SN1□	33ohm±25%	3000mA	0.025ohm max.	-55°C to +125°C	Kit ≥3A
BLM18PG600SN1□	60ohm(Typ.)	500mA	0.10ohm max.	-55°C to +125°C	Kit
BLM18PG121SN1□	120ohm±25%	2000mA	0.05ohm max.	-55°C to +125°C	Kit ≥1A
BLM18PG181SN1□	180ohm±25%	1500mA	0.09ohm max.	-55°C to +125°C	Kit ≥1A
BLM18PG221SN1□	220ohm±25%	1400mA	0.10ohm max.	-55°C to +125°C	Kit ≥1A
BLM18PG331SN1□	330ohm±25%	1200mA	0.15ohm max.	-55°C to +125°C	Kit ≥1A
BLM18PG471SN1□	470ohm±25%	1000mA	0.20ohm max.	-55°C to +125°C	Kit ≥1A

Number of Circuits: 1

### ■ Impedance-Frequency Characteristics (Main Items)

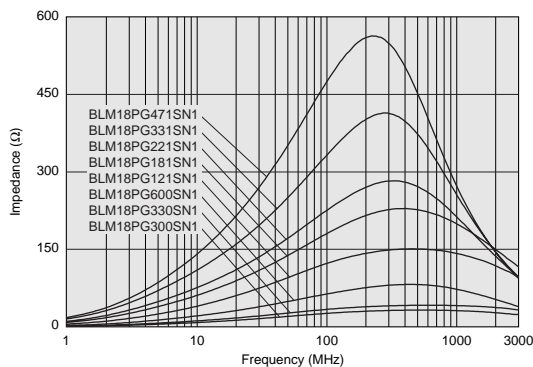

### ■ Notice (Rating)

In operating temperature exceeding +85°C, derating of current is necessary for BLM18PG series. Please apply the derating curve shown in chart according to the operating temperature.

#### Derating

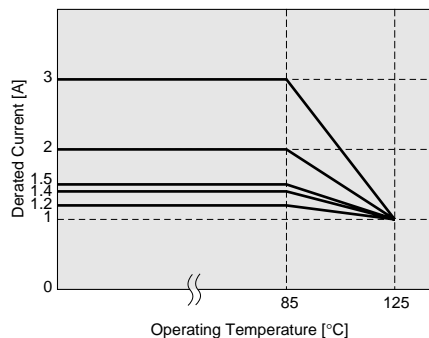

Continued on the following page. ↗

Chip EMIFIL®

Chip Common Mode Choke Coil

Block Type EMIFIL®

△Note • Please read rating and △CAUTION (for storage, operating, rating, soldering, mounting and handling) in this catalog to prevent smoking and/or burning, etc.  
 • This catalog has only typical specifications because there is no space for detailed specifications. Therefore, please review our product specifications or consult the approval sheet for product specifications before ordering.

Impedance-Frequency Characteristics

BLM18PG300SN1

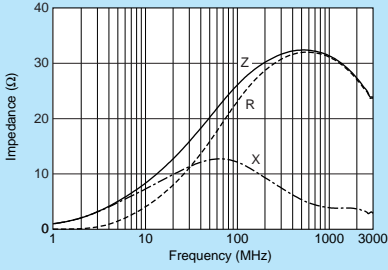

BLM18PG330SN1

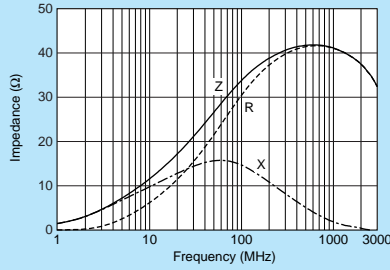

BLM18PG600SN1

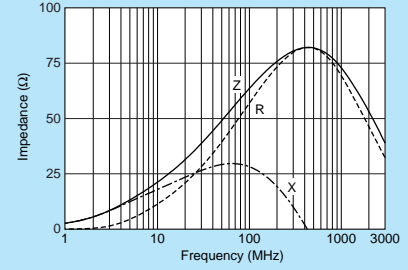

BLM18PG121SN1

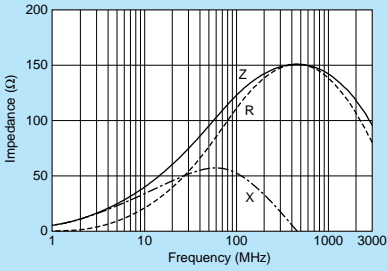

BLM18PG181SN1

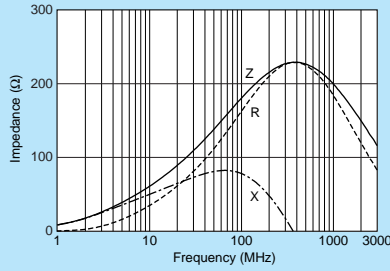

BLM18PG221SN1

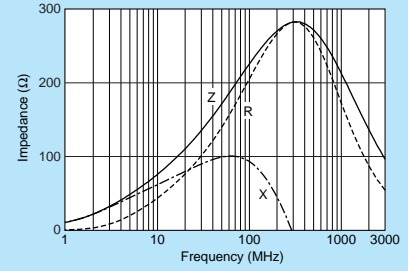

BLM18PG331SN1

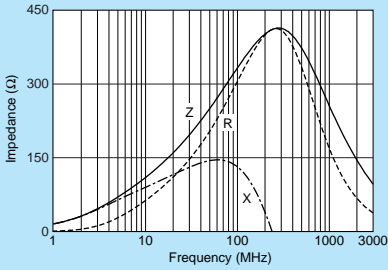

BLM18PG471SN1

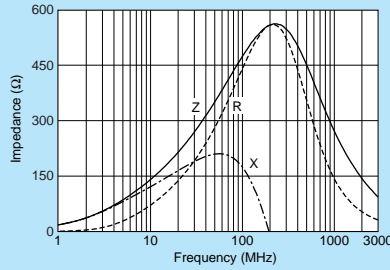

Note • Please read rating and CAUTION (for storage, operating, rating, soldering, mounting and handling) in this catalog to prevent smoking and/or burning, etc.  
 • This catalog has only typical specifications because there is no space for detailed specifications. Therefore, please review our product specifications or consult the approval sheet for product specifications before ordering.



# BLM21P Series (0805 Size)



## 0805 size for power lines.

\*Please refer to the products which are designed for both power lines and signal lines. \*Please refer to BLM18K for downsizing.

### ■ Dimensions

0.5±0.2  
2.0±0.2  
1.25±0.2  
0.85±0.2

EIA CODE : 0805  
■ : Electrode  
(in mm)

### ■ Equivalent Circuit

(Resistance element becomes dominant at high frequencies.)

### ■ Packaging

Code	Packaging	Minimum Quantity
D	180mm Reel Paper Tape	4000
J	330mm Reel Paper Tape	10000
B	Bulk(Bag)	1000

Refer to pages from p.91 to p.94 for mounting information.

### ■ Rated Value (□: packaging code)

Part Number	Impedance (at 100MHz/20°C)	Rated Current	DC Resistance	Operating Temperature Range	Kit	Current
BLM21PG220SN1□	22ohm±25%	6000mA	0.01ohm max.	-55°C to +125°C	Kit	≥3A
BLM21PG300SN1□	30ohm(Typ.)	3000mA	0.015ohm max.	-55°C to +125°C	Kit	≥3A
BLM21PG600SN1□	60ohm±25%	3000mA	0.025ohm max.	-55°C to +125°C	Kit	≥3A
BLM21PG121SN1□	120ohm±25%	3000mA	0.03ohm max.	-55°C to +125°C	Kit	≥3A
BLM21PG221SN1□	220ohm±25%	2000mA	0.050ohm max.	-55°C to +125°C	Kit	≥1A
BLM21PG331SN1□	330ohm±25%	1500mA	0.09ohm max.	-55°C to +125°C	Kit	≥1A

Number of Circuits: 1

### ■ Impedance-Frequency Characteristics (Main Items)

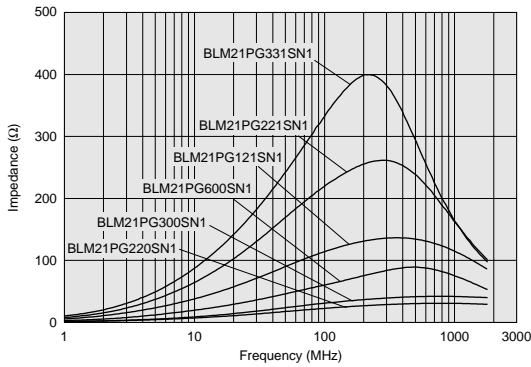

### ■ Notice (Rating)

In operating temperature exceeding +85°C, derating of current is necessary for BLM21PG series.

Please apply the derating curve shown in chart according to the operating temperature.

#### Derating

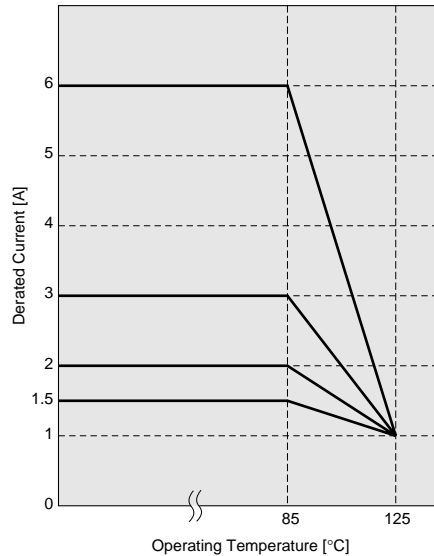

Continued on the following page. ↗

△Note • Please read rating and △CAUTION (for storage, operating, rating, soldering, mounting and handling) in this catalog to prevent smoking and/or burning, etc.

• This catalog has only typical specifications because there is no space for detailed specifications. Therefore, please review our product specifications or consult the approval sheet for product specifications before ordering.

Impedance-Frequency Characteristics

BLM21PG220SN1

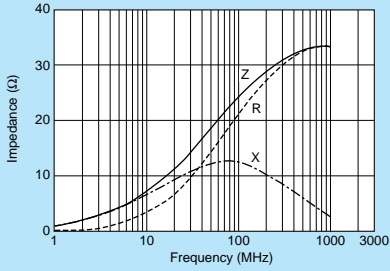

BLM21PG300SN1

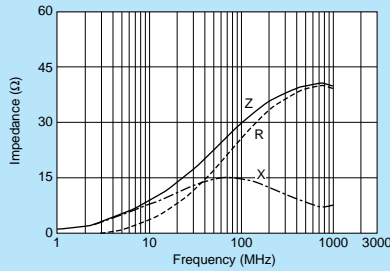

BLM21PG600SN1

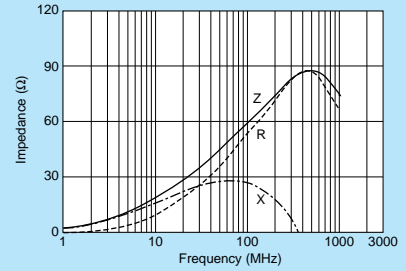

BLM21PG121SN1

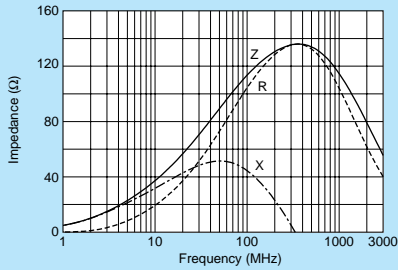

BLM21PG221SN1

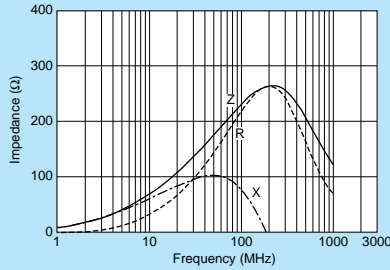

BLM21PG331SN1

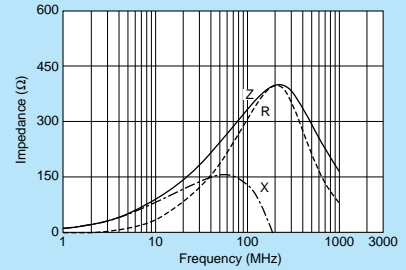

Power Lines Type  
Chip Ferrite Bead

Chip EMIFIL®

Chip Common Mode Choke Coil

Block Type EMIFIL®

⚠Note • Please read rating and ⚠CAUTION (for storage, operating, rating, soldering, mounting and handling) in this catalog to prevent smoking and/or burning, etc.  
 • This catalog has only typical specifications because there is no space for detailed specifications. Therefore, please review our product specifications or consult the approval sheet for product specifications before ordering.

# BLM31P Series (1206 Size)



## 1206 size for power lines.

\*Please refer to the products which are designed for both power lines and signal lines.

Chip Ferrite Bead  
Power Lines Type

Chip EMIFIL®

Chip Common Mode Choke Coil

Block Type EMIFIL®



### ■ Dimensions

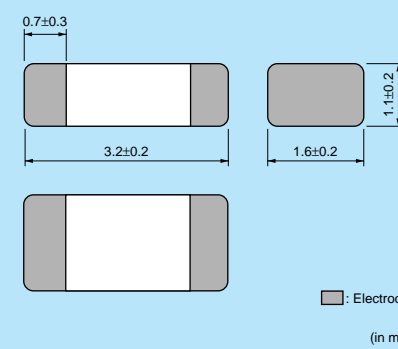

■ Electrode  
(in mm)

### ■ Equivalent Circuit



(Resistance element becomes dominant at high frequencies.)

### ■ Packaging

Code	Packaging	Minimum Quantity
L	180mm Reel Embossed Tape	3000
K	330mm Reel Embossed Tape	10000
B	Bulk(Bag)	1000

Refer to pages from p.91 to p.94 for mounting information.

### ■ Rated Value (□: packaging code)

Part Number	Impedance (at 100MHz/20°C)	Rated Current	DC Resistance	Operating Temperature Range		
BLM31PG330SN1□	33ohm±25%	6000mA	0.01ohm max.	-55°C to +125°C	Kit	≥3A
BLM31PG500SN1□	50ohm(Typ.)	3000mA	0.025ohm max.	-55°C to +125°C	Kit	≥3A
BLM31PG121SN1□	120ohm±25%	3000mA	0.025ohm max.	-55°C to +125°C	Kit	≥3A
BLM31PG391SN1□	390ohm±25%	2000mA	0.05ohm max.	-55°C to +125°C	Kit	≥1A
BLM31PG601SN1□	600ohm±25%	1500mA	0.09ohm max.	-55°C to +125°C	Kit	≥1A

Number of Circuits: 1

### ■ Impedance-Frequency Characteristics (Main Items)

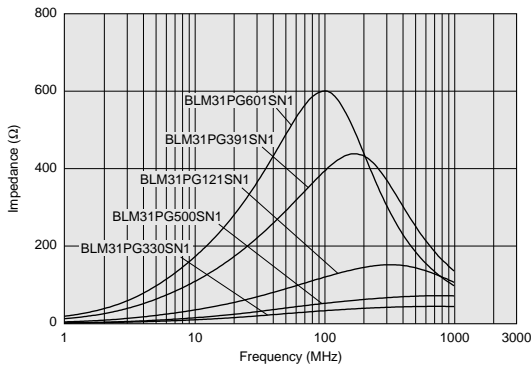

### ■ Notice (Rating)

In operating temperature exceeding +85°C, derating of current is necessary for BLM31PG series.

Please apply the derating curve shown in chart according to the operating temperature.

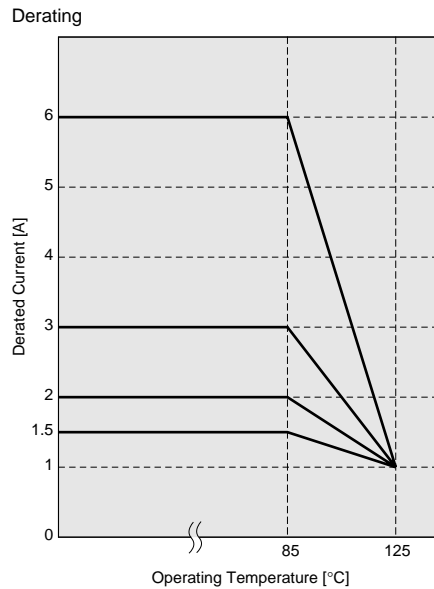

Continued on the following page.

△Note • Please read rating and △CAUTION (for storage, operating, rating, soldering, mounting and handling) in this catalog to prevent smoking and/or burning, etc.  
• This catalog has only typical specifications because there is no space for detailed specifications. Therefore, please review our product specifications or consult the approval sheet for product specifications before ordering.

Impedance-Frequency Characteristics

BLM31PG330SN1

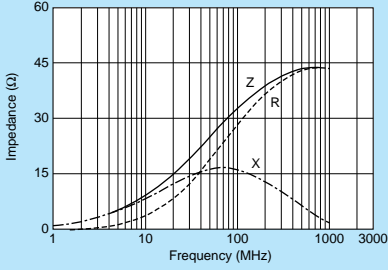

BLM31PG500SN1

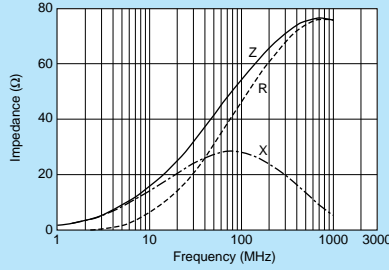

BLM31PG121SN1

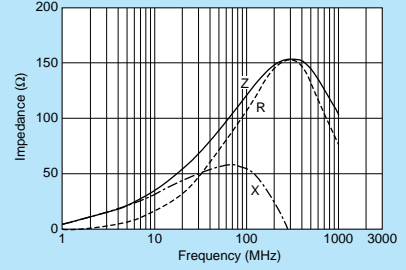

BLM31PG391SN1

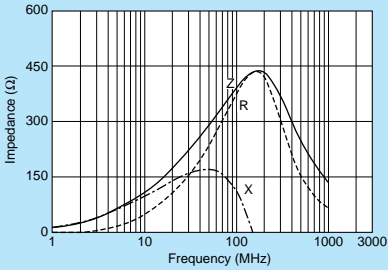

BLM31PG601SN1

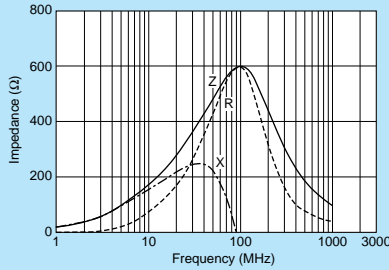

Power Lines Type  
Chip Ferrite Bead

Chip EMIFIL®

Chip Common Mode Choke Coil

Block Type EMIFIL®

△Note • Please read rating and △CAUTION (for storage, operating, rating, soldering, mounting and handling) in this catalog to prevent smoking and/or burning, etc.  
 • This catalog has only typical specifications because there is no space for detailed specifications. Therefore, please review our product specifications or consult the approval sheet for product specifications before ordering.

# BLM41P Series (1806 Size)



## 1806 size for power lines.

\*Please refer to the products which are designed for both power lines and signal lines.

Chip Ferrite Bead  
Power Lines Type

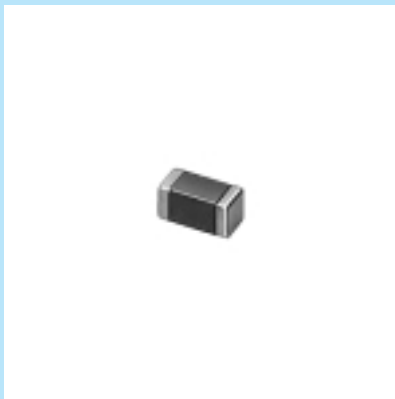

### ■ Dimensions

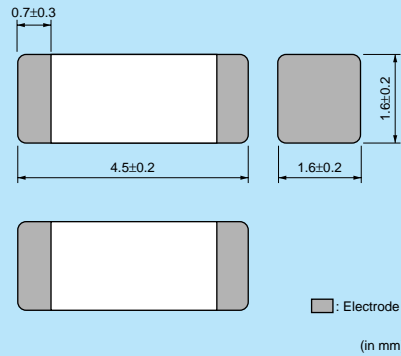

### ■ Equivalent Circuit

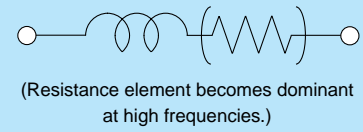

### ■ Packaging

Code	Packaging	Minimum Quantity
L	180mm Reel Embossed Tape	2500
K	330mm Reel Embossed Tape	8000
B	Bulk(Bag)	1000

Refer to pages from p.91 to p.94 for mounting information.

### ■ Rated Value (□: packaging code)

Part Number	Impedance (at 100MHz/20°C)	Rated Current	DC Resistance	Operating Temperature Range		
BLM41PG600SN1□	60ohm(Typ.)	6000mA	0.01ohm max.	-55°C to +125°C	Kit	≥3A
BLM41PG750SN1□	75ohm(Typ.)	3000mA	0.025ohm max.	-55°C to +125°C	Kit	≥3A
BLM41PG181SN1□	180ohm±25%	3000mA	0.025ohm max.	-55°C to +125°C	Kit	≥3A
BLM41PG471SN1□	470ohm±25%	2000mA	0.05ohm max.	-55°C to +125°C	Kit	≥1A
BLM41PG102SN1□	1000ohm±25%	1500mA	0.09ohm max.	-55°C to +125°C	Kit	≥1A

Number of Circuits: 1

### ■ Impedance-Frequency Characteristics (Main Items)

#### BLM41PG Series (60ohm to 180ohm)

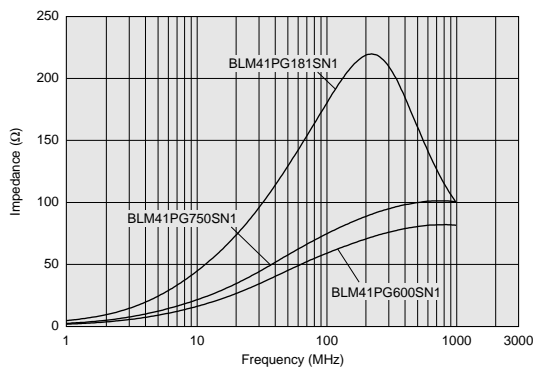

#### BLM41PG Series (470ohm to 1000ohm)

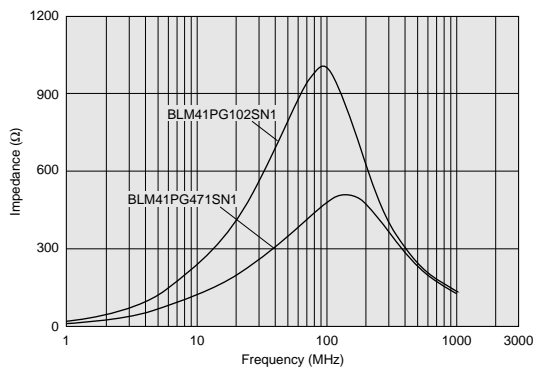

### ■ Notice (Rating)

In operating temperature exceeding +85°C, derating of current is necessary for BLM41PG series.

Please apply the derating curve shown in chart according to the operating temperature.

#### Derating

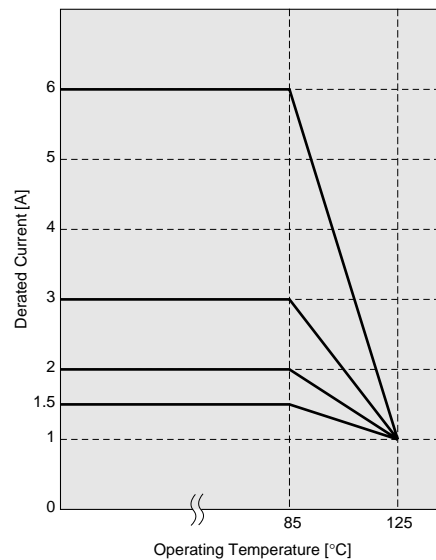

Continued on the following page.

△Note • Please read rating and △CAUTION (for storage, operating, rating, soldering, mounting and handling) in this catalog to prevent smoking and/or burning, etc.  
• This catalog has only typical specifications because there is no space for detailed specifications. Therefore, please review our product specifications or consult the approval sheet for product specifications before ordering.

Chip EMIFIL®

Chip Common Mode Choke Coil

Block Type EMIFIL®

Impedance-Frequency Characteristics

BLM41PG600SN1

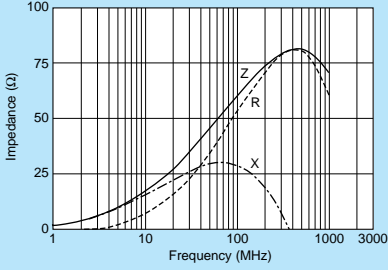

BLM41PG750SN1

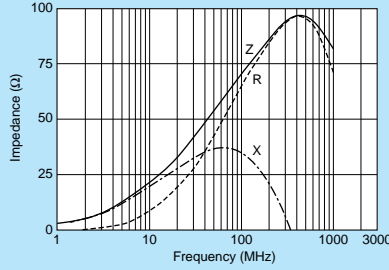

BLM41PG181SN1

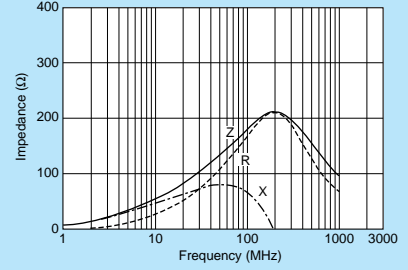

BLM41PG471SN1

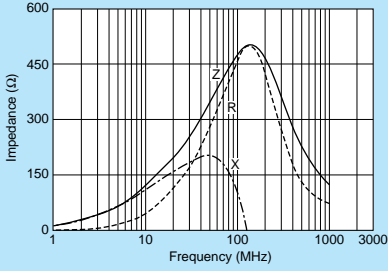

BLM41PG102SN1

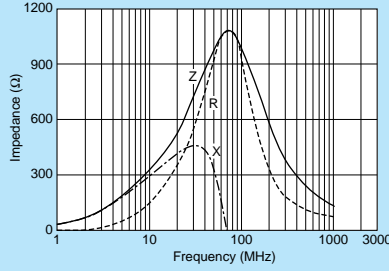

Power Lines Type  
Chip Ferrite Bead

Chip EMIFIL®

Chip Common Mode Choke Coil

Block Type EMIFIL®

⚠Note • Please read rating and ⚠CAUTION (for storage, operating, rating, soldering, mounting and handling) in this catalog to prevent smoking and/or burning, etc.  
 • This catalog has only typical specifications because there is no space for detailed specifications. Therefore, please review our product specifications or consult the approval sheet for product specifications before ordering.

# BLM18K Series (0603 Size)



6A Max, high performance type for power lines up to 600ohm.

\*Please refer to the products which are designed for both power lines and signal lines.

Chip Ferrite Bead  
Power Lines Type

Chip EMIFIL®

Chip Common Mode Choke Coil

Block Type EMIFIL®



### ■ Dimensions

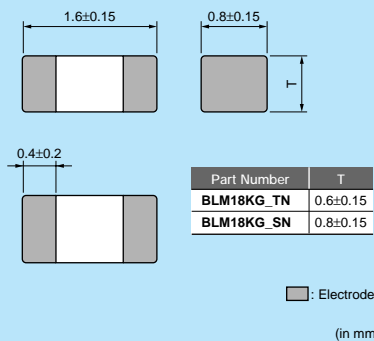

### ■ Equivalent Circuit

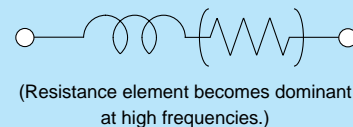

### ■ Packaging

Code	Packaging	Minimum Quantity
D	180mm Reel Paper Tape	4000
J	330mm Reel Paper Tape	10000
B	Bulk(Bag)	1000

Refer to pages from p.91 to p.94 for mounting information.

### ■ Rated Value (□: packaging code)

Part Number	Impedance (at 100MHz/20°C)	Rated Current	DC Resistance	Operating Temperature Range		
BLM18KG260TN1□	26ohm±25%	6000mA	0.007ohm max.	-55°C to +125°C	Kit	≥3A
BLM18KG300TN1□	30ohm±25%	5000mA	0.010ohm max.	-55°C to +125°C	Kit	≥3A
BLM18KG700TN1□	70ohm±25%	3500mA	0.022ohm max.	-55°C to +125°C	Kit	≥3A
BLM18KG101TN1□	100ohm±25%	3000mA	0.030ohm max.	-55°C to +125°C	Kit	≥3A
BLM18KG121TN1□	120ohm±25%	3000mA	0.030ohm max.	-55°C to +125°C	Kit	≥3A
BLM18KG221SN1□	220ohm±25%	2200mA	0.050ohm max.	-55°C to +125°C	Kit	≥1A
BLM18KG331SN1□	330ohm±25%	1700mA	0.080ohm max.	-55°C to +125°C	Kit	≥1A
BLM18KG471SN1□	470ohm±25%	1500mA	0.130ohm max.	-55°C to +125°C	Kit	≥1A
BLM18KG601SN1□	600ohm±25%	1300mA	0.150ohm max.	-55°C to +125°C	Kit	≥1A

Number of Circuits: 1

### ■ Impedance-Frequency Characteristics (Main Items)

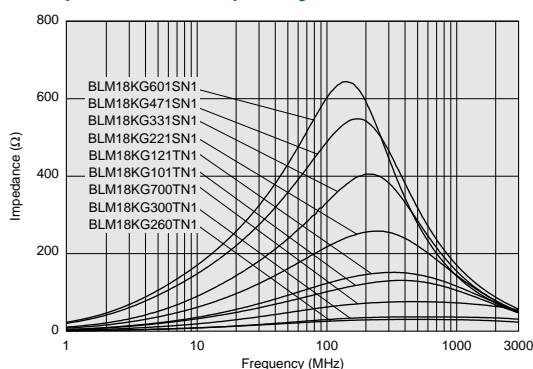

### ■ Notice (Rating)

In operating temperature exceeding +85°C, derating of current is necessary for BLM18KG series. Please apply the derating curve shown in chart according to the operating temperature.

#### Derating

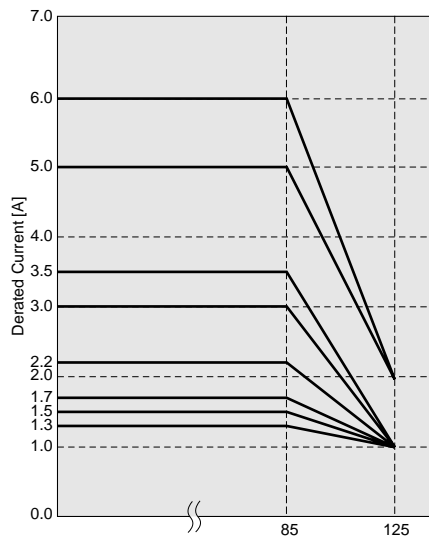

Continued on the following page. ↗

△Note • Please read rating and △CAUTION (for storage, operating, rating, soldering, mounting and handling) in this catalog to prevent smoking and/or burning, etc.  
• This catalog has only typical specifications because there is no space for detailed specifications. Therefore, please review our product specifications or consult the approval sheet for product specifications before ordering.

Impedance-Frequency Characteristics

BLM18KG260TN1

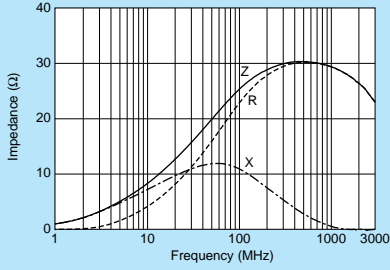

BLM18KG300TN1

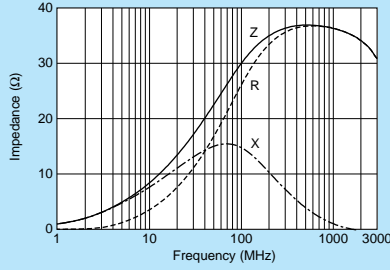

BLM18KG700TN1

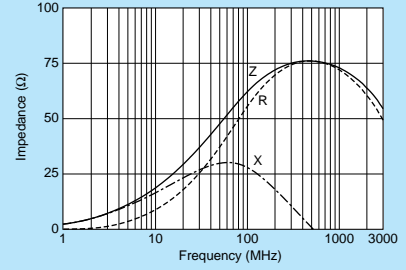

BLM18KG101TN1

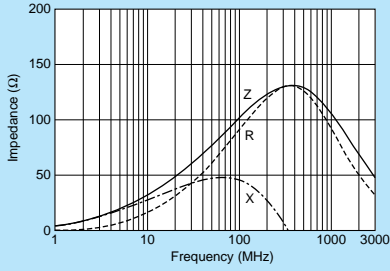

BLM18KG121TN1

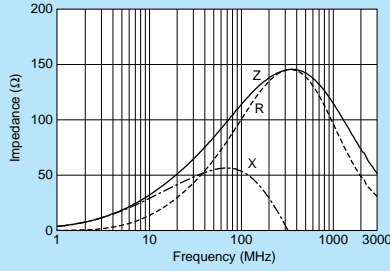

BLM18KG221SN1

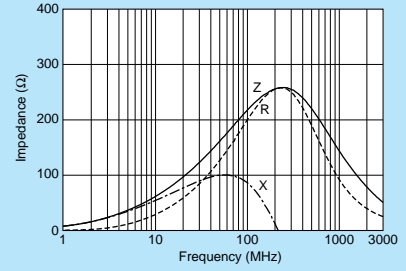

BLM18KG331SN1

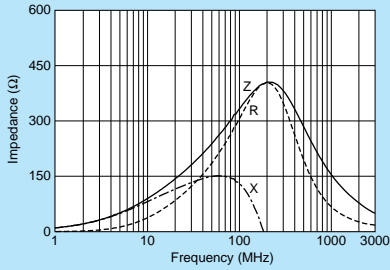

BLM18KG471SN1

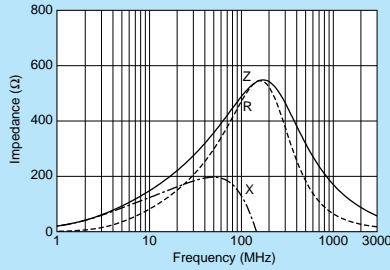

BLM18KG601SN1

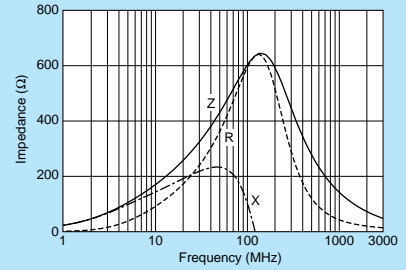

Note • Please read rating and CAUTION (for storage, operating, rating, soldering, mounting and handling) in this catalog to prevent smoking and/or burning, etc.  
 • This catalog has only typical specifications because there is no space for detailed specifications. Therefore, please review our product specifications or consult the approval sheet for product specifications before ordering.



# BLM18S Series (0603 Size)



6A Max, high performance type for power lines.

\*Please refer to the products which are designed for both power lines and signal lines.

Chip Ferrite Bead Power Lines Type

Chip EMIFIL®

Chip Common Mode Choke Coil

Block Type EMIFIL®

### ■ Dimensions

■ Electrode  
(in mm)

### ■ Equivalent Circuit

(Resistance element becomes dominant at high frequencies.)

### ■ Packaging

Code	Packaging	Minimum Quantity
D	180mm Reel Paper Tape	10000
J	330mm Reel Paper Tape	30000
B	Bulk(Bag)	1000

Refer to pages from p.91 to p.94 for mounting information.

### ■ Rated Value (□: packaging code)

Part Number	Impedance (at 100MHz/20°C)	Rated Current	DC Resistance	Operating Temperature Range		
BLM18SG260TN1□	26ohm±25%	6000mA	0.007ohm max.	-55°C to +125°C	Kit	≥3A
BLM18SG700TN1□	70ohm±25%	4000mA	0.020ohm max.	-55°C to +125°C	Kit	≥3A
BLM18SG121TN1□	120ohm±25%	3000mA	0.025ohm max.	-55°C to +125°C	Kit	≥3A
BLM18SG221TN1□	220ohm±25%	2500mA	0.040ohm max.	-55°C to +125°C	Kit	≥1A
BLM18SG331TN1□	330ohm±25%	1500mA	0.070ohm max.	-55°C to +125°C	Kit	≥1A

Number of Circuits: 1

### ■ Impedance-Frequency Characteristics (Main Items)

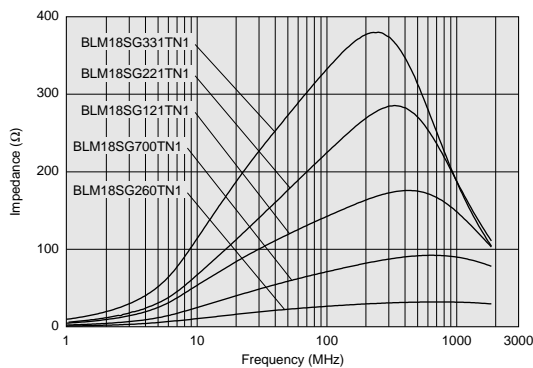

### ■ Notice (Rating)

In operating temperature exceeding +85°C, derating of current is necessary for BLM18SG series.

Please apply the derating curve shown in chart according to the operating temperature.

Derating

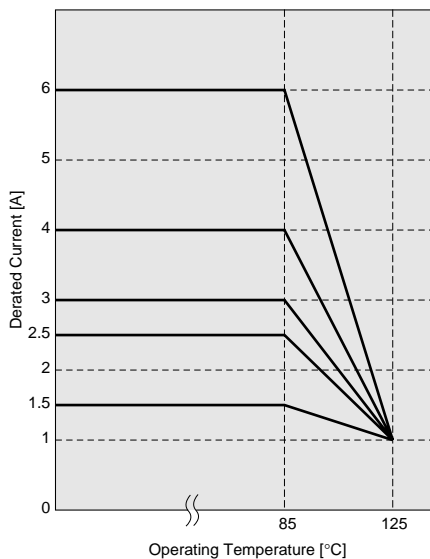

Continued on the following page.

△Note • Please read rating and △CAUTION (for storage, operating, rating, soldering, mounting and handling) in this catalog to prevent smoking and/or burning, etc.  
 • This catalog has only typical specifications because there is no space for detailed specifications. Therefore, please review our product specifications or consult the approval sheet for product specifications before ordering.

Impedance-Frequency Characteristics

BLM18SG260TN1

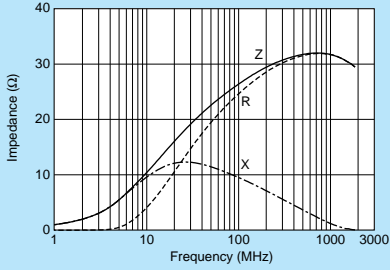

BLM18SG700TN1

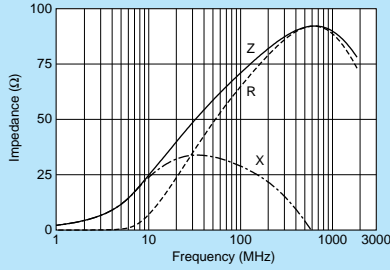

BLM18SG121TN1

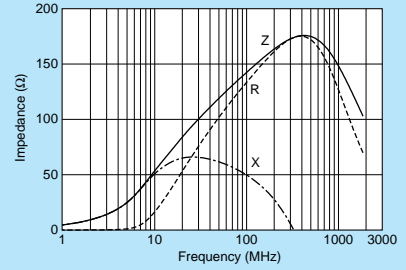

BLM18SG221TN1

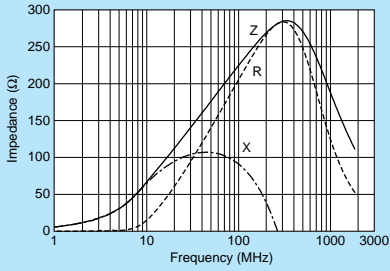

BLM18SG331TN1

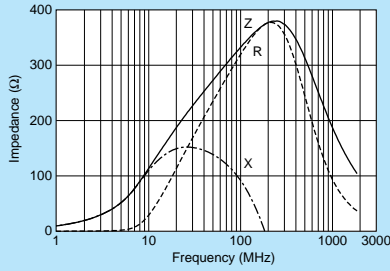

Power Lines Type  
Chip Ferrite Bead

Chip EMIFIL®

Chip Common Mode Choke Coil

Block Type EMIFIL®

⚠Note • Please read rating and ⚠CAUTION (for storage, operating, rating, soldering, mounting and handling) in this catalog to prevent smoking and/or burning, etc.  
 • This catalog has only typical specifications because there is no space for detailed specifications. Therefore, please review our product specifications or consult the approval sheet for product specifications before ordering.

# BLM02A Series (01005 Size)



Ultra small 01005 size for general signal lines.

Chip Ferrite Bead  
Signal Lines Type

Chip EMIFIL®

Chip Common Mode Choke Coil

Block Type EMIFIL®



### ■ Dimensions

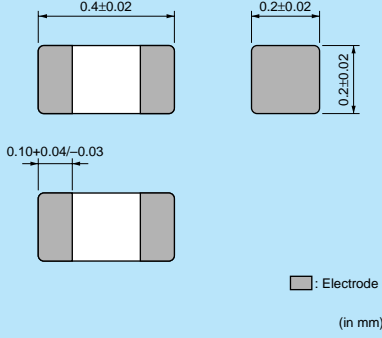

■ Electrode  
(in mm)

### ■ Equivalent Circuit

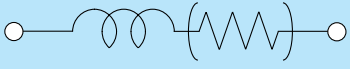

(Resistance element becomes dominant at high frequencies.)

### ■ Packaging

Code	Packaging	Minimum Quantity
D	180mm Reel Paper Tape	20000
B	Bulk(Bag)	1000

Refer to pages from p.91 to p.94 for mounting information.

### ■ Rated Value (□: packaging code)

Part Number	Impedance (at 100MHz/20°C)	Rated Current	DC Resistance	Operating Temperature Range	
BLM02AG100SN1□	10ohm(Typ.)	500mA	0.1ohm max.	-55°C to +125°C	<b>Kit</b>
BLM02AG700SN1□	70ohm±25%	250mA	0.5ohm max.	-55°C to +125°C	<b>Kit</b>
BLM02AG121SN1□	120ohm±25%	200mA	0.8ohm max.	-55°C to +125°C	<b>Kit</b>

Number of Circuits: 1

### ■ Impedance-Frequency Characteristics (Main Items)

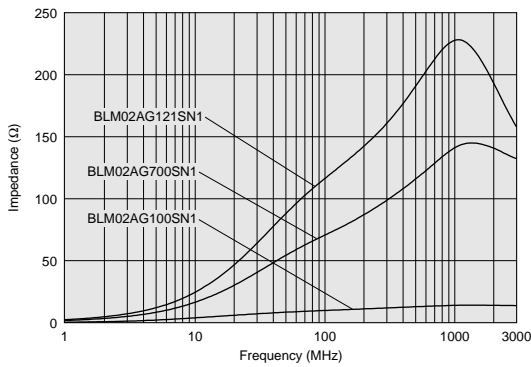

### ■ Impedance-Frequency Characteristics

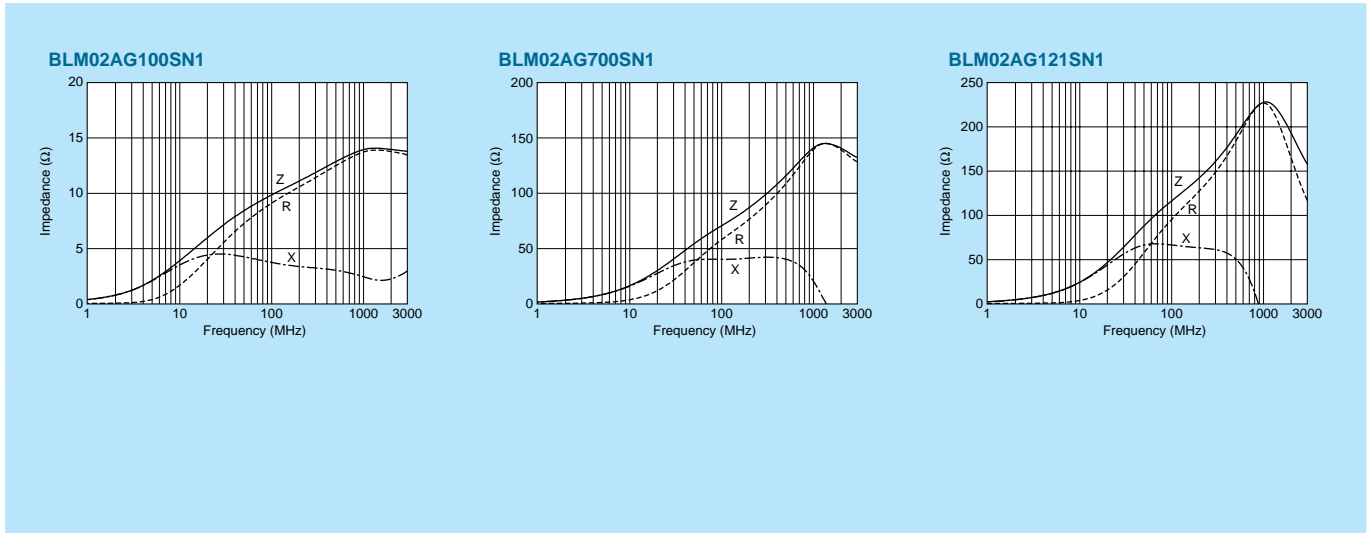

△Note • Please read rating and △CAUTION (for storage, operating, rating, soldering, mounting and handling) in this catalog to prevent smoking and/or burning, etc.  
• This catalog has only typical specifications because there is no space for detailed specifications. Therefore, please review our product specifications or consult the approval sheet for product specifications before ordering.

# BLM03AG Series (0201 Size)



0201 size for general signal lines.

### ■ Dimensions

■: Electrode  
(in mm)

### ■ Equivalent Circuit

(Resistance element becomes dominant at high frequencies.)

### ■ Packaging

Code	Packaging	Minimum Quantity
D	180mm Reel Paper Tape	15000
J	330mm Reel Paper Tape	50000
B	Bulk(Bag)	1000

Refer to pages from p.91 to p.94 for mounting information.

### ■ Rated Value (□: packaging code)

Part Number	Impedance (at 100MHz/20°C)	Rated Current	DC Resistance	Operating Temperature Range	
BLM03AG100SN1□	10ohm(Typ.)	500mA	0.1ohm max.	-55°C to +125°C	Kit
BLM03AG700SN1□	70ohm(Typ.)	200mA	0.4ohm max.	-55°C to +125°C	Kit
BLM03AG800SN1□	80ohm±25%	200mA	0.4ohm max.	-55°C to +125°C	Kit
BLM03AG121SN1□	120ohm±25%	200mA	0.5ohm max.	-55°C to +125°C	Kit
BLM03AG241SN1□	240ohm±25%	200mA	0.8ohm max.	-55°C to +125°C	Kit
BLM03AG601SN1□	600ohm±25%	100mA	1.5ohm max.	-55°C to +125°C	Kit
BLM03AG102SN1□	1000ohm±25%	100mA	2.5ohm max.	-55°C to +125°C	Kit

Number of Circuits: 1

### ■ Impedance-Frequency Characteristics (Main Items)

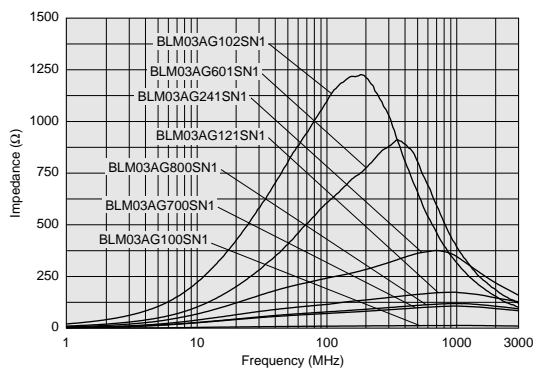

### ■ Impedance-Frequency Characteristics

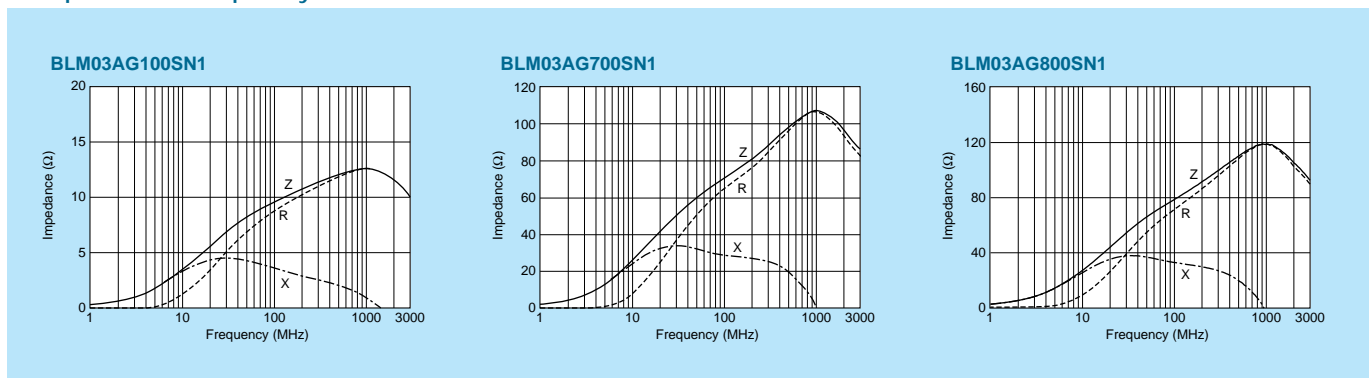

Continued on the following page.

△Note • Please read rating and △CAUTION (for storage, operating, rating, soldering, mounting and handling) in this catalog to prevent smoking and/or burning, etc.  
 • This catalog has only typical specifications because there is no space for detailed specifications. Therefore, please review our product specifications or consult the approval sheet for product specifications before ordering.

Impedance-Frequency Characteristics

Chip Ferrite Bead  
 Signal Lines Type

Chip EMIFIL®

Chip Common Mode Choke Coil

Block Type EMIFIL®

BLM03AG121SN1

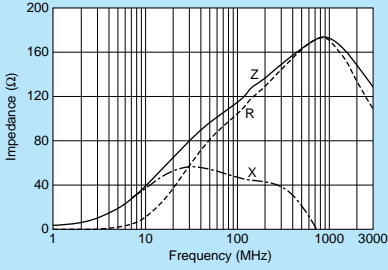

BLM03AG241SN1

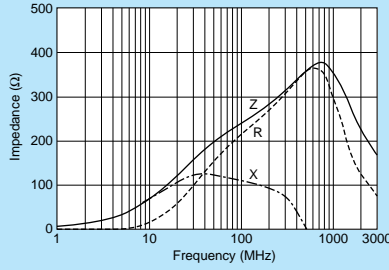

BLM03AG601SN1

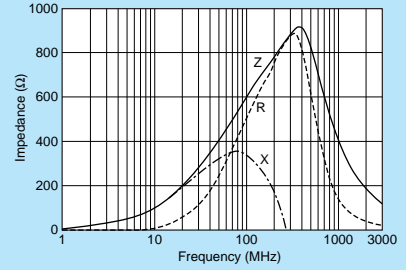

BLM03AG102SN1

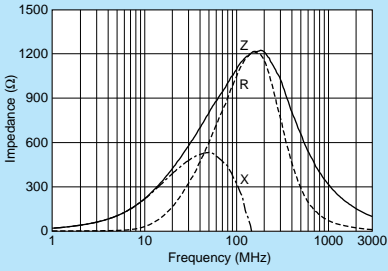

△Note • Please read rating and △CAUTION (for storage, operating, rating, soldering, mounting and handling) in this catalog to prevent smoking and/or burning, etc.  
 • This catalog has only typical specifications because there is no space for detailed specifications. Therefore, please review our product specifications or consult the approval sheet for product specifications before ordering.

# BLM15AG-SN Series (0402 Size)



0402 size for general signal lines.

### ■ Dimensions

Legend:  Electrode (in mm)

### ■ Equivalent Circuit

(Resistance element becomes dominant at high frequencies.)

### ■ Packaging

Code	Packaging	Minimum Quantity
D	180mm Reel Paper Tape	10000
J	330mm Reel Paper Tape	50000
B	Bulk(Bag)	1000

Refer to pages from p.91 to p.94 for mounting information.

### ■ Rated Value (□: packaging code)

Part Number	Impedance (at 100MHz/20°C)	Rated Current	DC Resistance	Operating Temperature Range	
BLM15AG100SN1□	10ohm(Typ.)	1000mA	0.05ohm max.	-55°C to +125°C	Kit $\geq 1A$
BLM15AG700SN1□	70ohm(Typ.)	500mA	0.15ohm max.	-55°C to +125°C	Kit
BLM15AG121SN1□	120ohm±25%	500mA	0.25ohm max.	-55°C to +125°C	Kit
BLM15AG221SN1□	220ohm±25%	300mA	0.35ohm max.	-55°C to +125°C	Kit
BLM15AG601SN1□	600ohm±25%	300mA	0.6ohm max.	-55°C to +125°C	Kit
BLM15AG102SN1□	1000ohm±25%	200mA	1.0ohm max.	-55°C to +125°C	Kit

Number of Circuits: 1

### ■ Impedance-Frequency Characteristics (Main Items)

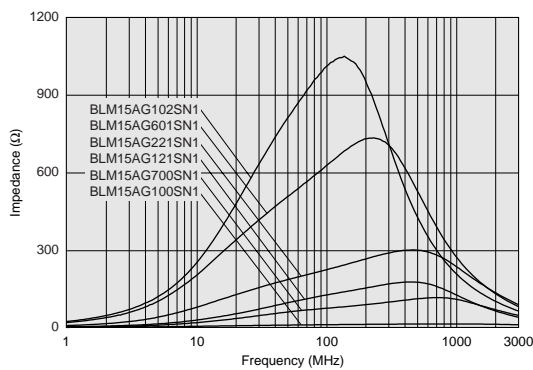

### ■ Impedance-Frequency Characteristics

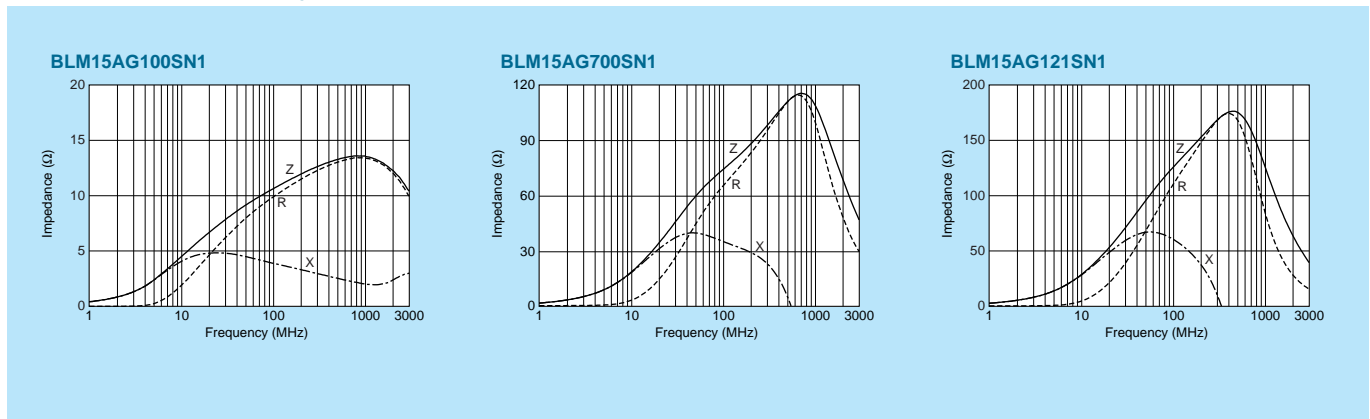

Continued on the following page.

⚠Note • Please read rating and ⚠CAUTION (for storage, operating, rating, soldering, mounting and handling) in this catalog to prevent smoking and/or burning, etc.  
 • This catalog has only typical specifications because there is no space for detailed specifications. Therefore, please review our product specifications or consult the approval sheet for product specifications before ordering.

Impedance-Frequency Characteristics

Chip Ferrite Bead  
 Signal Lines Type

Chip EMIFIL®

Chip Common Mode Choke Coil

Block Type EMIFIL®

BLM15AG221SN1

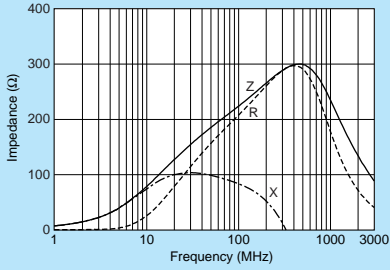

BLM15AG601SN1

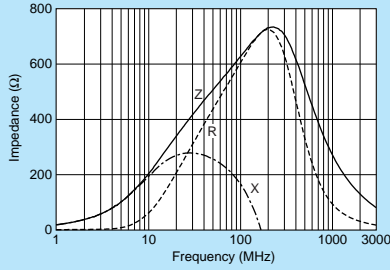

BLM15AG102SN1

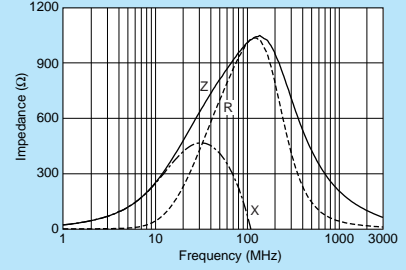

△Note • Please read rating and △CAUTION (for storage, operating, rating, soldering, mounting and handling) in this catalog to prevent smoking and/or burning, etc.  
 • This catalog has only typical specifications because there is no space for detailed specifications. Therefore, please review our product specifications or consult the approval sheet for product specifications before ordering.

# BLM15AG-AN Series Gold Plating (0402 Size)

Au plating electrode for wire bonding mount.



### ■ Dimensions

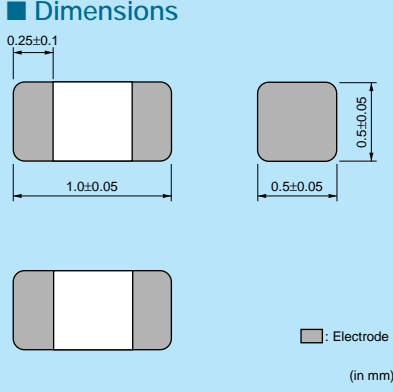

(in mm)

### ■ Equivalent Circuit

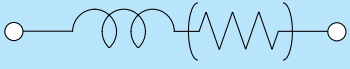

(Resistance element becomes dominant at high frequencies.)

### ■ Packaging

Code	Packaging	Minimum Quantity
D	180mm Reel Paper Tape	10000
J	330mm Reel Paper Tape	50000
B	Bulk(Bag)	1000

Refer to pages from p.91 to p.94 for mounting information.

### ■ Rated Value (□: packaging code)

Part Number	Impedance (at 100MHz/20°C)	Rated Current	DC Resistance	Operating Temperature Range
BLM15AG601AN1□	600ohm±25%	300mA	0.6ohm max.	-55°C to +125°C
BLM15AG102AN1□	1000ohm±25%	200mA	1.0ohm max.	-55°C to +125°C

Number of Circuits: 1

This product is Au plating version designed for wire bonding mount. Be sure that this product is not designed for solder mounting.

### ■ Impedance-Frequency Characteristics (Main Items)

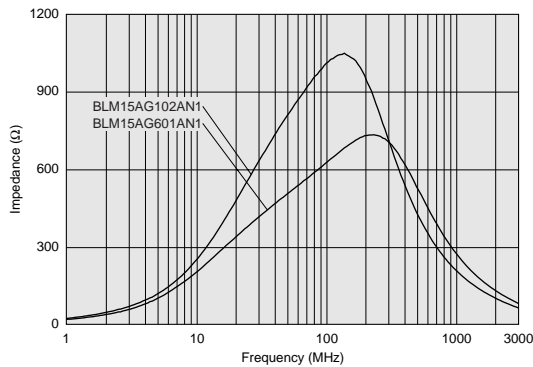

### ■ Impedance-Frequency Characteristics

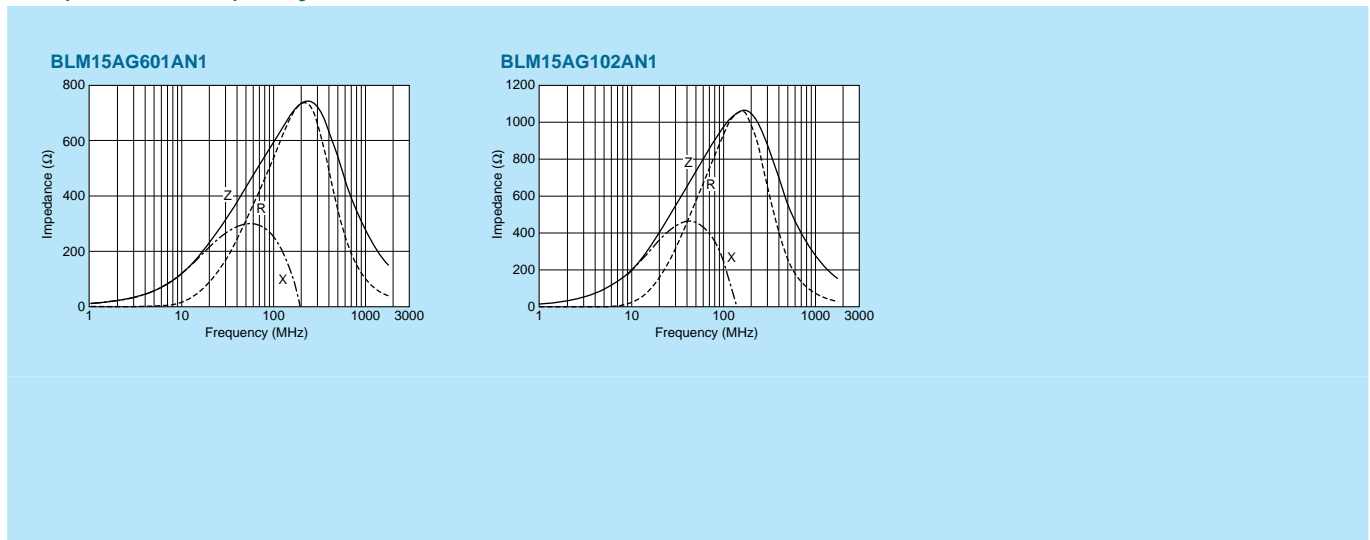

△Note • Please read rating and △CAUTION (for storage, operating, rating, soldering, mounting and handling) in this catalog to prevent smoking and/or burning, etc.  
 • This catalog has only typical specifications because there is no space for detailed specifications. Therefore, please review our product specifications or consult the approval sheet for product specifications before ordering.



# BLM18A Series (0603 Size)



0603 size for general signal lines.

\*Please refer to BLM15A for downsizing.

Chip Ferrite Bead  
Signal Lines Type

Chip EMIFIL®

Chip Common Mode Choke Coil

Block Type EMIFIL®



### ■ Dimensions

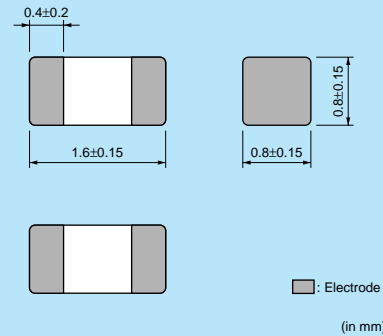

### ■ Equivalent Circuit

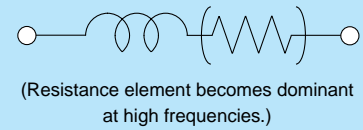

### ■ Packaging

Code	Packaging	Minimum Quantity
D	180mm Reel Paper Tape	4000
J	330mm Reel Paper Tape	10000
B	Bulk(Bag)	1000

Refer to pages from p.91 to p.94 for mounting information.

### ■ Rated Value (□: packaging code)

Part Number	Impedance (at 100MHz/20°C)	Rated Current	DC Resistance	Operating Temperature Range	
BLM18AG121SN1□	120ohm±25%	500mA	0.18ohm max.	-55°C to +125°C	Kit
BLM18AG151SN1□	150ohm±25%	500mA	0.25ohm max.	-55°C to +125°C	Kit
BLM18AG221SN1□	220ohm±25%	500mA	0.25ohm max.	-55°C to +125°C	Kit
BLM18AG331SN1□	330ohm±25%	500mA	0.30ohm max.	-55°C to +125°C	Kit
BLM18AG471SN1□	470ohm±25%	500mA	0.35ohm max.	-55°C to +125°C	Kit
BLM18AG601SN1□	600ohm±25%	500mA	0.38ohm max.	-55°C to +125°C	Kit
BLM18AG102SN1□	1000ohm±25%	400mA	0.50ohm max.	-55°C to +125°C	Kit

Number of Circuits: 1

### ■ Impedance-Frequency Characteristics (Main Items)

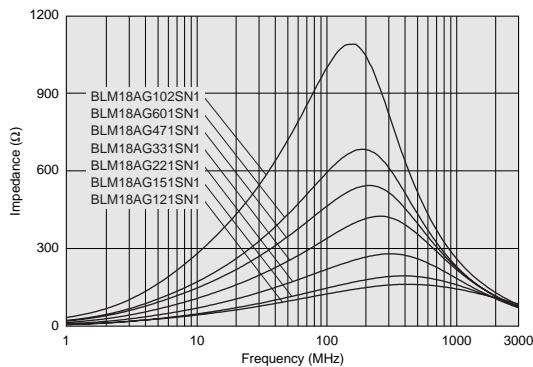

### ■ Impedance-Frequency Characteristics

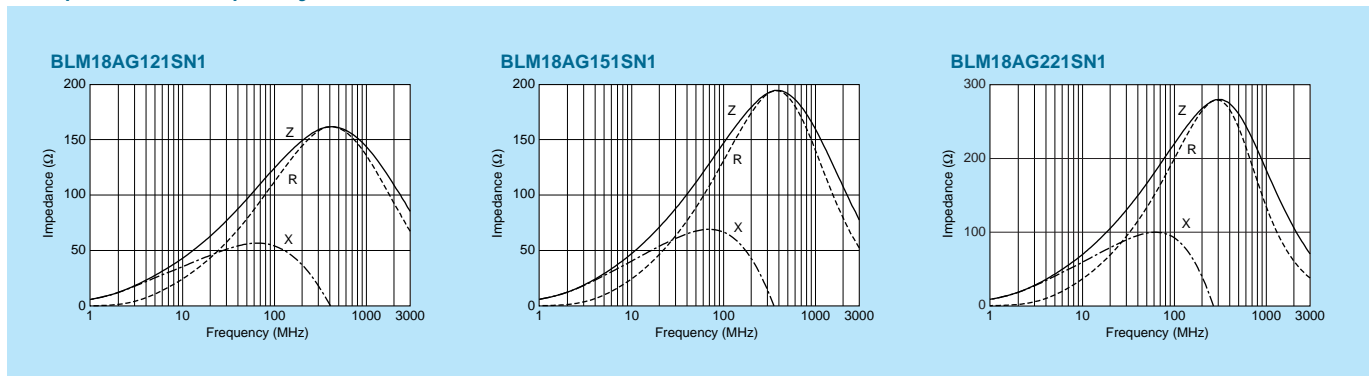

Continued on the following page. ↗

△Note • Please read rating and △CAUTION (for storage, operating, rating, soldering, mounting and handling) in this catalog to prevent smoking and/or burning, etc.  
• This catalog has only typical specifications because there is no space for detailed specifications. Therefore, please review our product specifications or consult the approval sheet for product specifications before ordering.

Impedance-Frequency Characteristics

BLM18AG331SN1

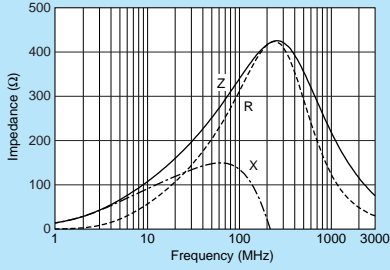

BLM18AG471SN1

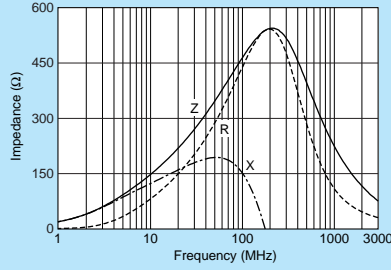

BLM18AG601SN1

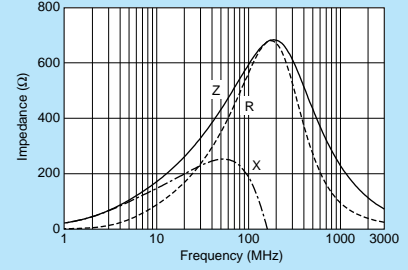

BLM18AG102SN1

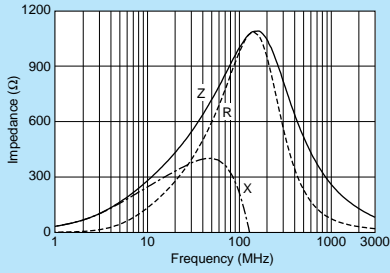

Note • Please read rating and CAUTION (for storage, operating, rating, soldering, mounting and handling) in this catalog to prevent smoking and/or burning, etc.  
 • This catalog has only typical specifications because there is no space for detailed specifications. Therefore, please review our product specifications or consult the approval sheet for product specifications before ordering.

# BLM21A Series (0805 Size)



0805 size for general signal lines.

Chip Ferrite Bead  
Signal Lines Type

Chip EMIFIL®

Chip Common Mode Choke Coil

Block Type EMIFIL®

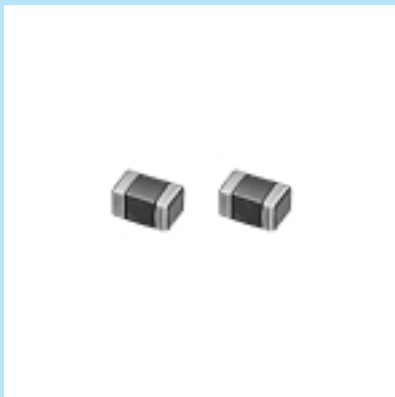

### ■ Dimensions

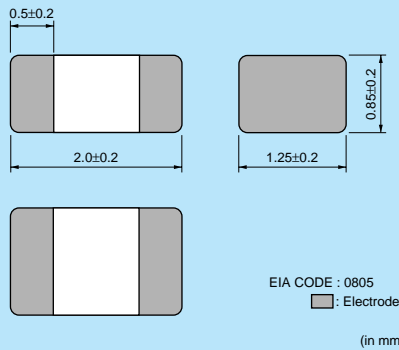

### ■ Equivalent Circuit

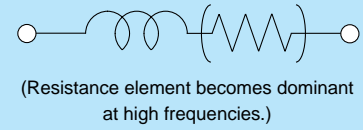

### ■ Packaging

Code	Packaging	Minimum Quantity
D	180mm Reel Paper Tape	4000
J	330mm Reel Paper Tape	10000
B	Bulk(Bag)	1000

Refer to pages from p.91 to p.94 for mounting information.

### ■ Rated Value (□: packaging code)

Part Number	Impedance (at 100MHz/20°C)	Rated Current	DC Resistance	Operating Temperature Range	
BLM21AG121SN1□	120ohm±25%	200mA	0.15ohm max.	-55°C to +125°C	Kit
BLM21AG151SN1□	150ohm±25%	200mA	0.15ohm max.	-55°C to +125°C	Kit
BLM21AG221SN1□	220ohm±25%	200mA	0.20ohm max.	-55°C to +125°C	Kit
BLM21AG331SN1□	330ohm±25%	200mA	0.25ohm max.	-55°C to +125°C	Kit
BLM21AG471SN1□	470ohm±25%	200mA	0.25ohm max.	-55°C to +125°C	Kit
BLM21AG601SN1□	600ohm±25%	200mA	0.30ohm max.	-55°C to +125°C	Kit
BLM21AG102SN1□	1000ohm±25%	200mA	0.45ohm max.	-55°C to +125°C	Kit

Number of Circuits: 1

### ■ Impedance-Frequency Characteristics (Main Items)

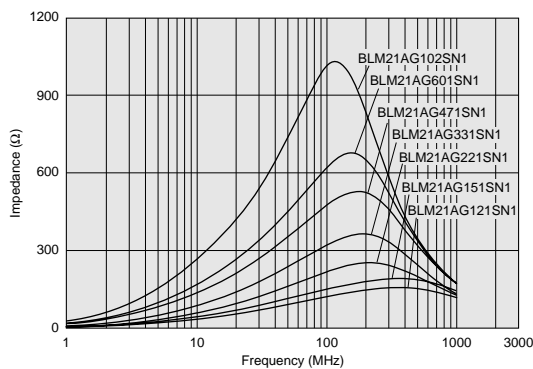

### ■ Impedance-Frequency Characteristics

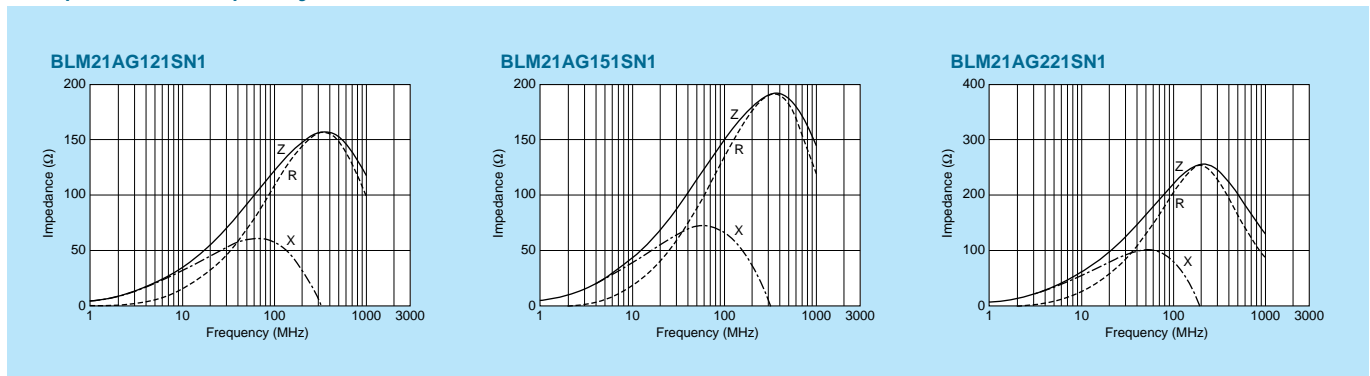

Continued on the following page. ↗

△Note • Please read rating and △CAUTION (for storage, operating, rating, soldering, mounting and handling) in this catalog to prevent smoking and/or burning, etc.  
• This catalog has only typical specifications because there is no space for detailed specifications. Therefore, please review our product specifications or consult the approval sheet for product specifications before ordering.

Impedance-Frequency Characteristics

BLM21AG331SN1

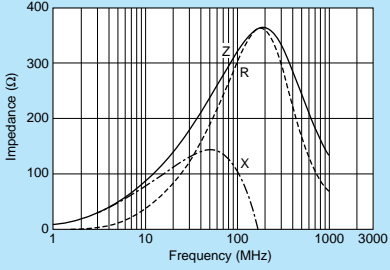

BLM21AG471SN1

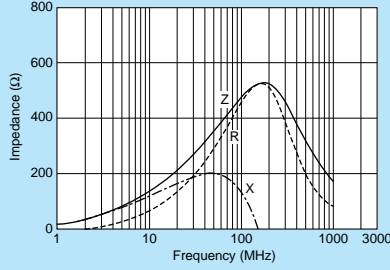

BLM21AG601SN1

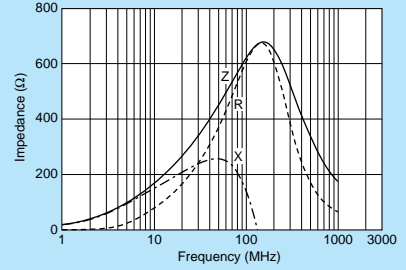

BLM21AG102SN1

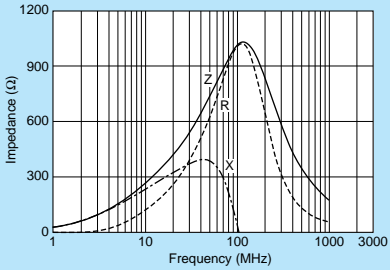

Signal Lines Type  
Chip Ferrite Bead

Chip EMIFIL®

Chip Common Mode Choke Coil

Block Type EMIFIL®

⚠Note • Please read rating and ⚠CAUTION (for storage, operating, rating, soldering, mounting and handling) in this catalog to prevent smoking and/or burning, etc.  
 • This catalog has only typical specifications because there is no space for detailed specifications. Therefore, please review our product specifications or consult the approval sheet for product specifications before ordering.

# BLM18T Series (0603 Size)



Thin 0603 size for general signal lines.

Chip Ferrite Bead  
Signal Lines Type

Chip EMIFIL®

Chip Common Mode Choke Coil

Block Type EMIFIL®



### ■ Dimensions

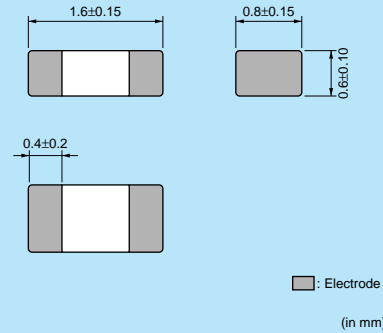

### ■ Equivalent Circuit

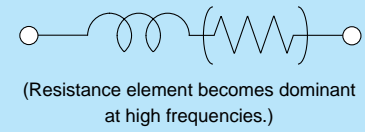

### ■ Packaging

Code	Packaging	Minimum Quantity
D	180mm Reel Paper Tape	10000
B	Bulk(Bag)	1000

Refer to pages from p.91 to p.94 for mounting information.

### ■ Rated Value (□: packaging code)

Part Number	Impedance (at 100MHz/20°C)	Rated Current	DC Resistance	Operating Temperature Range
BLM18TG121TN1□	120ohm±25%	200mA	0.25ohm max.	-55°C to +125°C
BLM18TG221TN1□	220ohm±25%	200mA	0.30ohm max.	-55°C to +125°C
BLM18TG601TN1□	600ohm±25%	200mA	0.45ohm max.	-55°C to +125°C
BLM18TG102TN1□	1000ohm±25%	100mA	0.60ohm max.	-55°C to +125°C

Number of Circuits: 1

### ■ Impedance-Frequency Characteristics (Main Items)

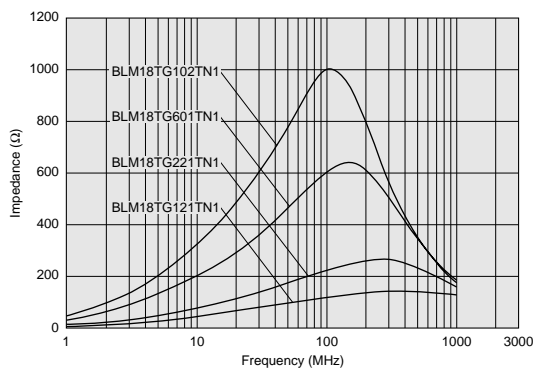

### ■ Impedance-Frequency Characteristics

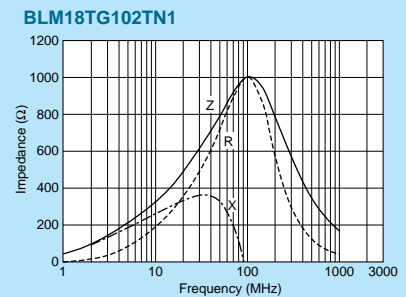
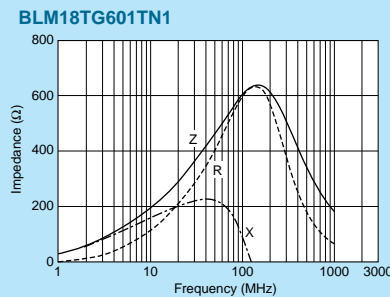
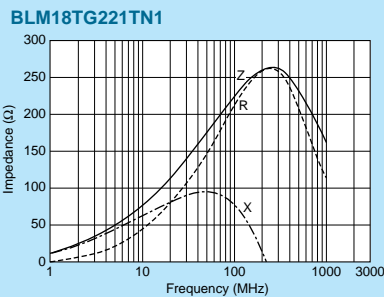
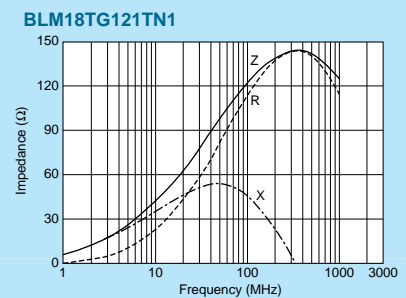

△Note • Please read rating and △CAUTION (for storage, operating, rating, soldering, mounting and handling) in this catalog to prevent smoking and/or burning, etc.  
• This catalog has only typical specifications because there is no space for detailed specifications. Therefore, please review our product specifications or consult the approval sheet for product specifications before ordering.

# BLM03B Series (0201 Size)



0201 size for high speed signal lines.

### ■ Dimensions

■: Electrode  
(in mm)

### ■ Equivalent Circuit

(Resistance element becomes dominant at high frequencies.)

### ■ Packaging

Code	Packaging	Minimum Quantity
D	180mm Reel Paper Tape	15000
J	330mm Reel Paper Tape	50000
B	Bulk(Bag)	1000

Refer to pages from p.91 to p.94 for mounting information.

### ■ Rated Value (□: packaging code)

Part Number	Impedance (at 100MHz/20°C)	Rated Current	DC Resistance	Operating Temperature Range	
BLM03BD750SN1□	75ohm±25%	300mA	0.4ohm max.	-55°C to +125°C	Kit
BLM03BD121SN1□	120ohm±25%	250mA	0.5ohm max.	-55°C to +125°C	Kit
BLM03BD241SN1□	240ohm±25%	200mA	0.8ohm max.	-55°C to +125°C	Kit
BLM03BD471SN1□	470ohm±25%	215mA	1.5ohm max.	-55°C to +125°C	Kit
BLM03BD601SN1□	600ohm±25%	200mA	1.7ohm max.	-55°C to +125°C	Kit
BLM03BB100SN1□	10ohm±25%	300mA	0.4ohm max.	-55°C to +125°C	Kit
BLM03BB220SN1□	22ohm±25%	200mA	0.5ohm max.	-55°C to +125°C	Kit
BLM03BB470SN1□	47ohm±25%	200mA	0.7ohm max.	-55°C to +125°C	Kit
BLM03BB750SN1□	75ohm±25%	200mA	1.0ohm max.	-55°C to +125°C	Kit
BLM03BB121SN1□	120ohm±25%	100mA	1.5ohm max.	-55°C to +125°C	Kit
BLM03BC330SN1□	33ohm±25%	150mA	0.85ohm max.	-55°C to +125°C	New Kit
BLM03BC560SN1□	56ohm±25%	100mA	1.05ohm max.	-55°C to +125°C	New Kit
BLM03BC800SN1□	80ohm±25%	100mA	1.40ohm max.	-55°C to +125°C	New Kit

Number of Circuits: 1

### ■ Impedance-Frequency Characteristics (Main Items)

#### BLM03BD Series

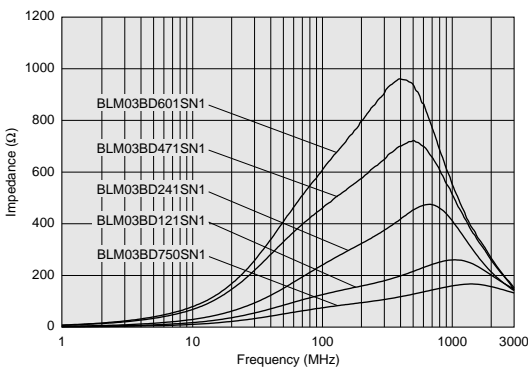

#### BLM03BB Series

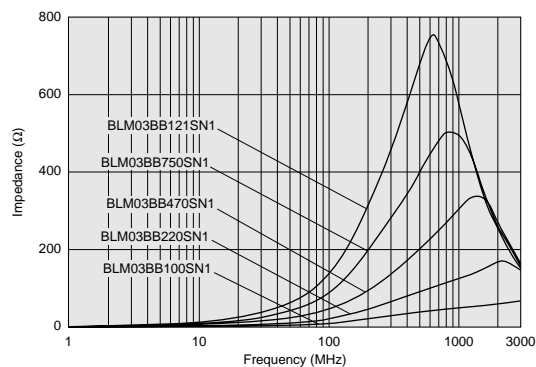

Continued on the following page. ↗

△Note • Please read rating and △CAUTION (for storage, operating, rating, soldering, mounting and handling) in this catalog to prevent smoking and/or burning, etc.  
• This catalog has only typical specifications because there is no space for detailed specifications. Therefore, please review our product specifications or consult the approval sheet for product specifications before ordering.

Impedance-Frequency Characteristics (Main Items)

BLM03BC Series

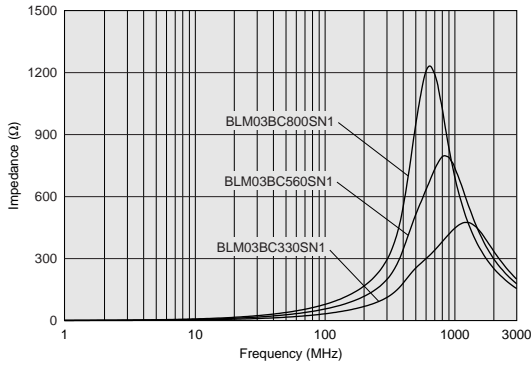

Impedance-Frequency Characteristics

BLM03BD750SN1

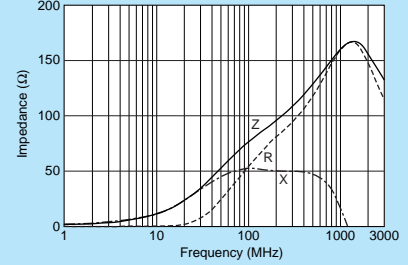

BLM03BD121SN1

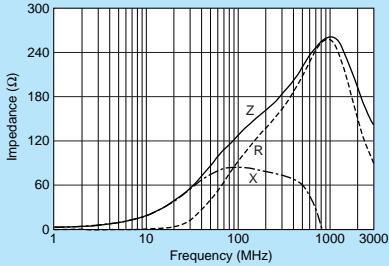

BLM03BD241SN1

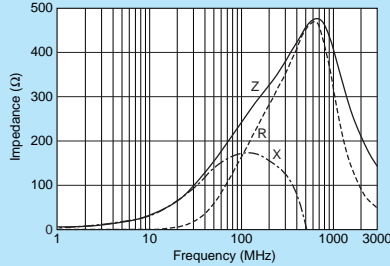

BLM03BD471SN1

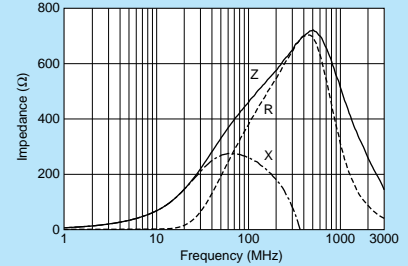

BLM03BD601SN1

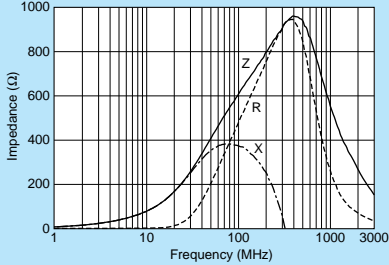

BLM03BB100SN1

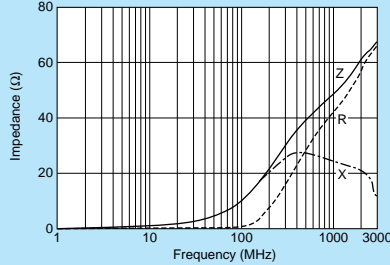

BLM03BB220SN1

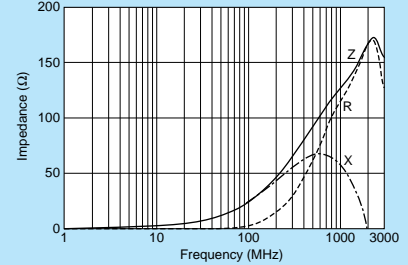

BLM03BB470SN1

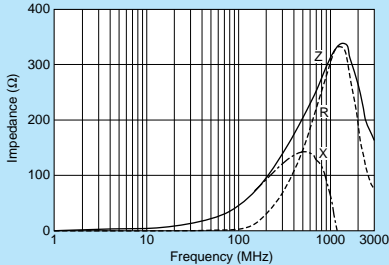

BLM03BB750SN1

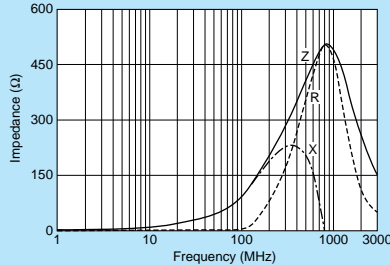

BLM03BB121SN1

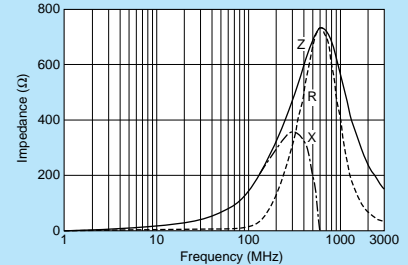

BLM03BC330SN1

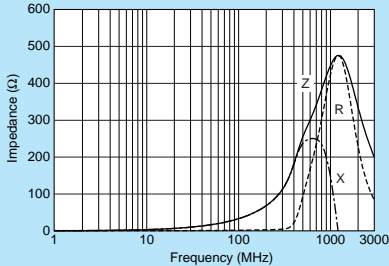

BLM03BC560SN1

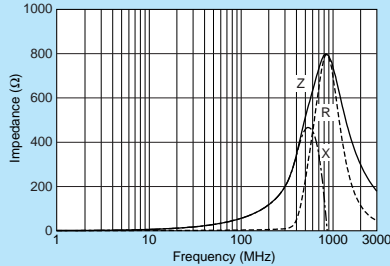

BLM03BC800SN1

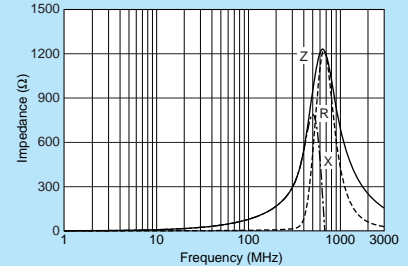

△Note • Please read rating and △CAUTION (for storage, operating, rating, soldering, mounting and handling) in this catalog to prevent smoking and/or burning, etc.  
 • This catalog has only typical specifications because there is no space for detailed specifications. Therefore, please review our product specifications or consult the approval sheet for product specifications before ordering.

# BLM15B Series (0402 Size)



0402 size for high speed signal lines.

### ■ Dimensions

(in mm)

### ■ Equivalent Circuit

(Resistance element becomes dominant at high frequencies.)

### ■ Packaging

Code	Packaging	Minimum Quantity
D	180mm Reel Paper Tape	10000
J	330mm Reel Paper Tape	50000
B	Bulk(Bag)	1000

Refer to pages from p.91 to p.94 for mounting information.

### ■ Rated Value (□: packaging code)

Part Number	Impedance (at 100MHz/20°C)	Rated Current	DC Resistance	Operating Temperature Range	
BLM15BD750SN1□	75ohm±25%	300mA	0.20ohm max.	-55°C to +125°C	Kit
BLM15BD121SN1□	120ohm±25%	300mA	0.30ohm max.	-55°C to +125°C	Kit
BLM15BD221SN1□	220ohm±25%	300mA	0.40ohm max.	-55°C to +125°C	Kit
BLM15BD471SN1□	470ohm±25%	200mA	0.60ohm max.	-55°C to +125°C	Kit
BLM15BD601SN1□	600ohm±25%	200mA	0.65ohm max.	-55°C to +125°C	Kit
BLM15BD102SN1□	1000ohm±25%	200mA	0.90ohm max.	-55°C to +125°C	Kit
BLM15BD182SN1□	1800ohm±25%	100mA	1.40ohm max.	-55°C to +125°C	Kit
BLM15BB050SN1□	5ohm±25%	500mA	0.08ohm max.	-55°C to +125°C	Kit
BLM15BB100SN1□	10ohm±25%	300mA	0.10ohm max.	-55°C to +125°C	Kit
BLM15BB220SN1□	22ohm±25%	300mA	0.20ohm max.	-55°C to +125°C	Kit
BLM15BB470SN1□	47ohm±25%	300mA	0.35ohm max.	-55°C to +125°C	Kit
BLM15BB750SN1□	75ohm±25%	300mA	0.40ohm max.	-55°C to +125°C	Kit
BLM15BB121SN1□	120ohm±25%	300mA	0.55ohm max.	-55°C to +125°C	Kit
BLM15BB221SN1□	220ohm±25%	200mA	0.80ohm max.	-55°C to +125°C	Kit
BLM15BC121SN1□	120ohm±25%	350mA	0.45ohm max.	-55°C to +125°C	Kit
BLM15BC241SN1□	240ohm±25%	250mA	0.70ohm max.	-55°C to +125°C	Kit
BLM15BA050SN1□	5ohm±25%	300mA	0.10ohm max.	-55°C to +125°C	Kit
BLM15BA100SN1□	10ohm±25%	300mA	0.20ohm max.	-55°C to +125°C	Kit
BLM15BA220SN1□	22ohm±25%	300mA	0.30ohm max.	-55°C to +125°C	Kit
BLM15BA330SN1□	33ohm±25%	300mA	0.40ohm max.	-55°C to +125°C	Kit
BLM15BA470SN1□	47ohm±25%	200mA	0.60ohm max.	-55°C to +125°C	Kit
BLM15BA750SN1□	75ohm±25%	200mA	0.80ohm max.	-55°C to +125°C	Kit

Number of Circuits: 1

Continued on the following page.

△Note • Please read rating and △CAUTION (for storage, operating, rating, soldering, mounting and handling) in this catalog to prevent smoking and/or burning, etc.  
 • This catalog has only typical specifications because there is no space for detailed specifications. Therefore, please review our product specifications or consult the approval sheet for product specifications before ordering.



Impedance-Frequency Characteristics (Main Items)

BLM15BD Series

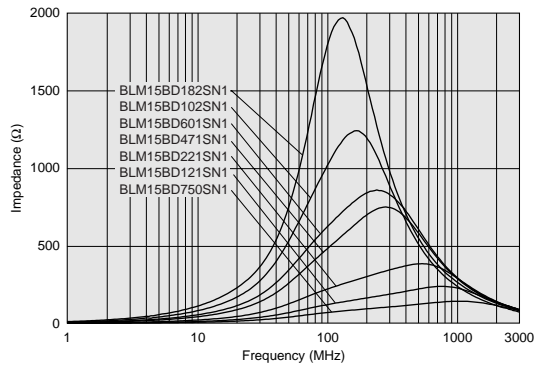

BLM15BB Series

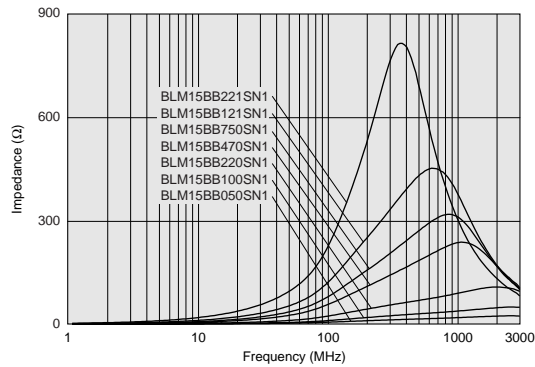

BLM15BC Series

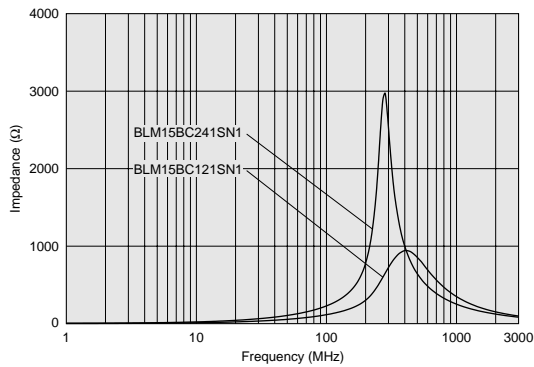

BLM15BA Series

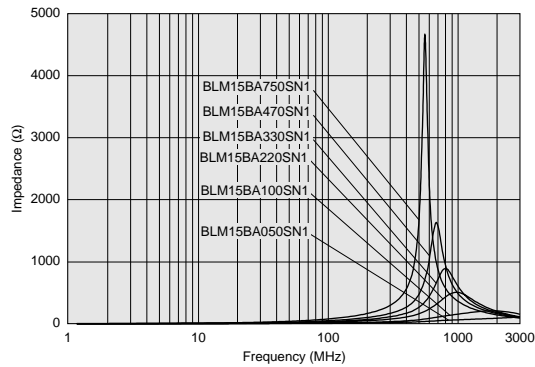

Impedance-Frequency Characteristics

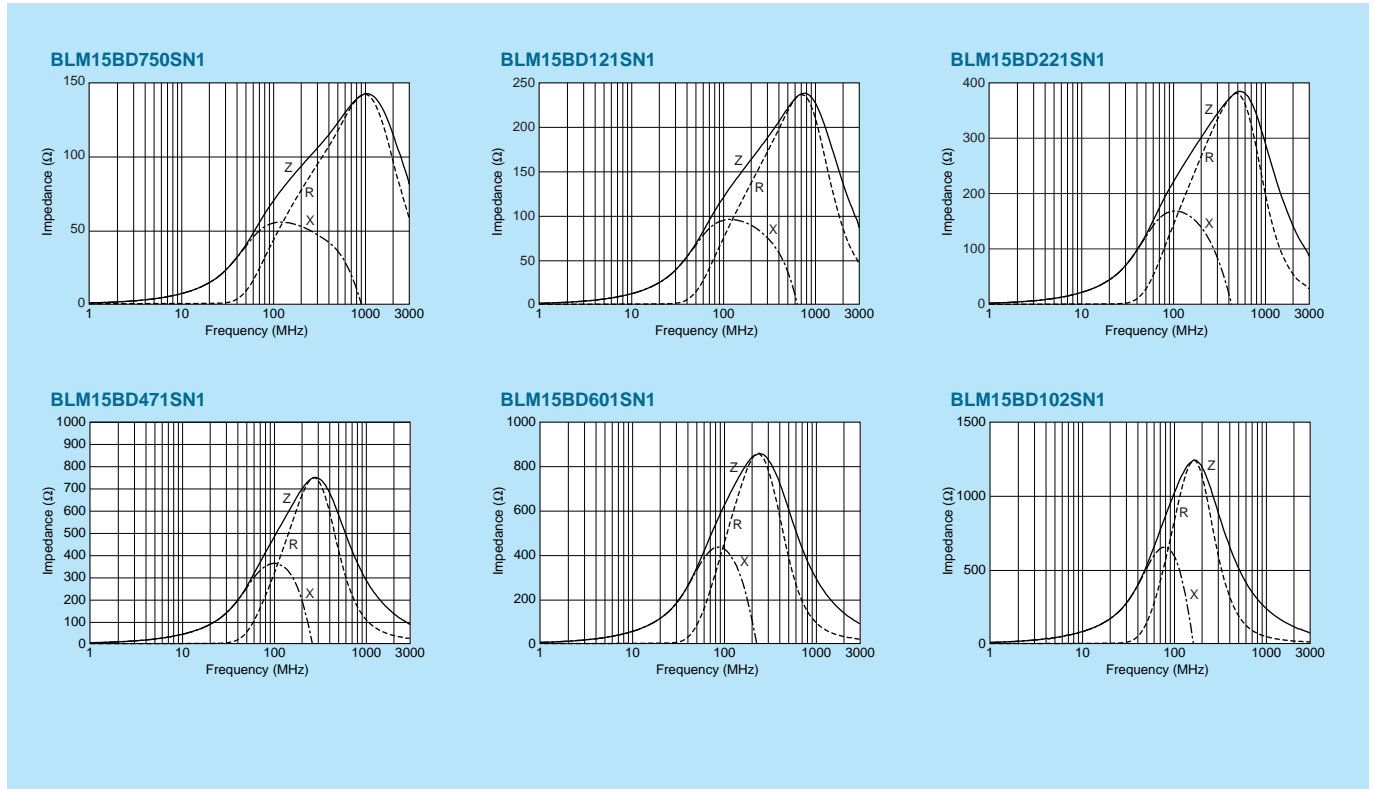

Continued on the following page.

**Note** • Please read rating and **CAUTION** (for storage, operating, rating, soldering, mounting and handling) in this catalog to prevent smoking and/or burning, etc.  
 • This catalog has only typical specifications because there is no space for detailed specifications. Therefore, please review our product specifications or consult the approval sheet for product specifications before ordering.

Impedance-Frequency Characteristics

BLM15BD182SN1

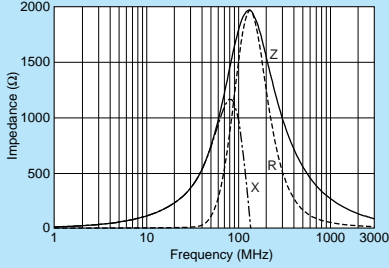

BLM15BB050SN1

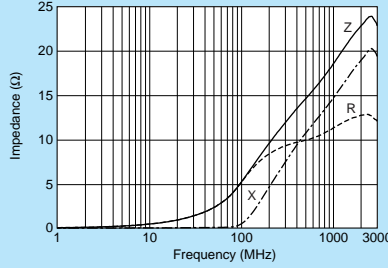

BLM15BB100SN1

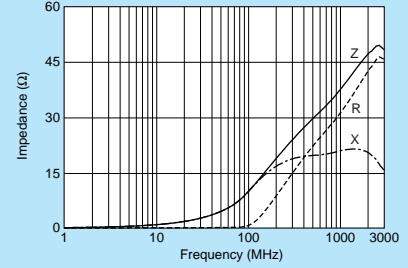

BLM15BB220SN1

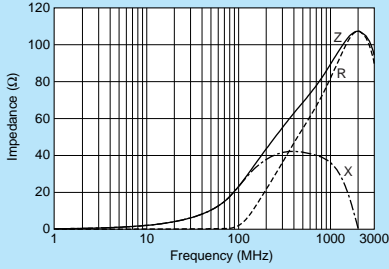

BLM15BB470SN1

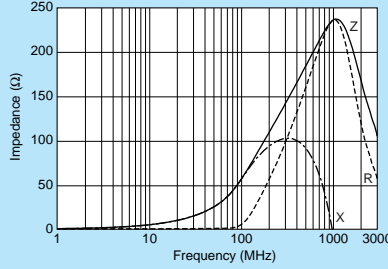

BLM15BB750SN1

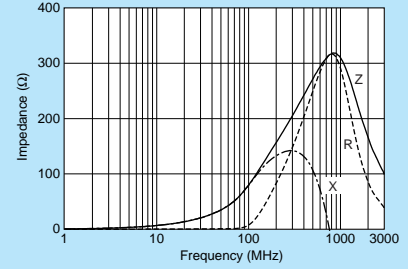

BLM15BB121SN1

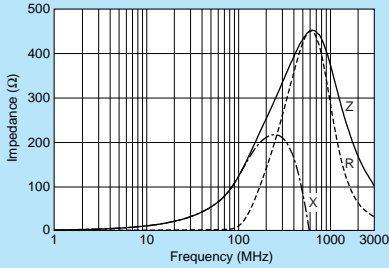

BLM15BB221SN1

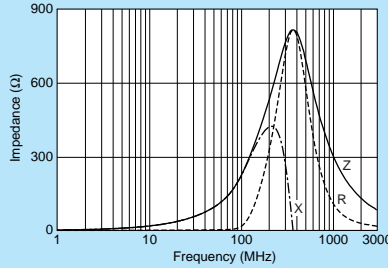

BLM15BC121SN1

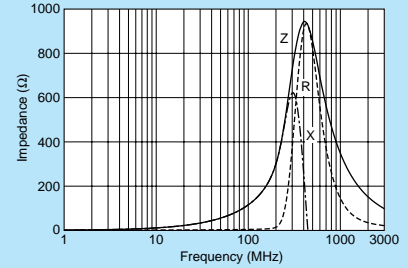

BLM15BC241SN1

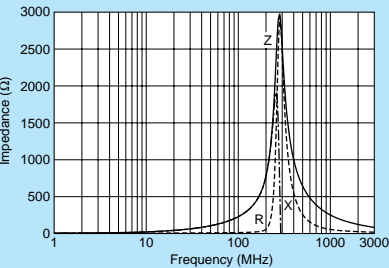

BLM15BA050SN1

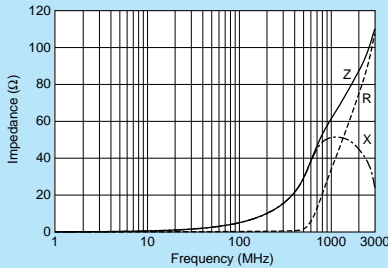

BLM15BA100SN1

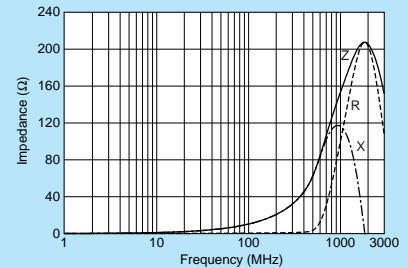

BLM15BA220SN1

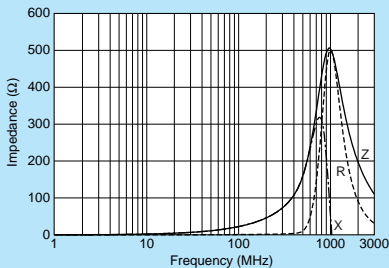

BLM15BA330SN1

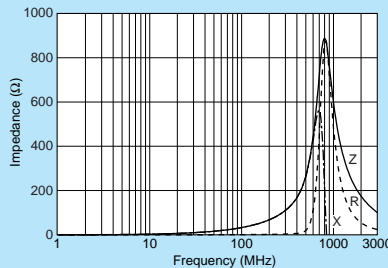

BLM15BA470SN1

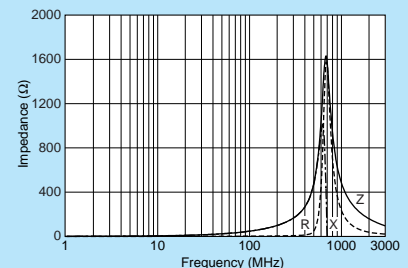

Continued on the following page. ↗

⚠Note • Please read rating and ⚠CAUTION (for storage, operating, rating, soldering, mounting and handling) in this catalog to prevent smoking and/or burning, etc.  
 • This catalog has only typical specifications because there is no space for detailed specifications. Therefore, please review our product specifications or consult the approval sheet for product specifications before ordering.

### Impedance-Frequency Characteristics

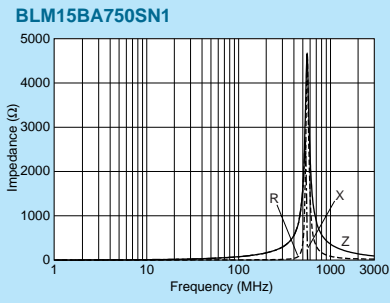

Chip Ferrite Bead  
Signal Lines Type

Chip EMIFIL®

Chip Common Mode Choke Coil

Block Type EMIFIL®

△Note • Please read rating and △CAUTION (for storage, operating, rating, soldering, mounting and handling) in this catalog to prevent smoking and/or burning, etc.  
• This catalog has only typical specifications because there is no space for detailed specifications. Therefore, please review our product specifications or consult the approval sheet for product specifications before ordering.

# BLM18B Series (0603 Size)



0603 size for high speed signal lines.

\*Please refer to BLM15B for downsizing.

### ■ Dimensions

(in mm)

### ■ Equivalent Circuit

(Resistance element becomes dominant at high frequencies.)

### ■ Packaging

Code	Packaging	Minimum Quantity
D	180mm Reel Paper Tape	4000
J	330mm Reel Paper Tape	10000
B	Bulk(Bag)	1000

Refer to pages from p.91 to p.94 for mounting information.

### ■ Rated Value (□: packaging code)

Part Number	Impedance (at 100MHz/20°C)	Rated Current	DC Resistance	Operating Temperature Range	
BLM18BD470SN1□	47ohm±25%	500mA	0.30ohm max.	-55°C to +125°C	Kit
BLM18BD121SN1□	120ohm±25%	200mA	0.40ohm max.	-55°C to +125°C	Kit
BLM18BD151SN1□	150ohm±25%	200mA	0.40ohm max.	-55°C to +125°C	Kit
BLM18BD221SN1□	220ohm±25%	200mA	0.45ohm max.	-55°C to +125°C	Kit
BLM18BD331SN1□	330ohm±25%	200mA	0.50ohm max.	-55°C to +125°C	Kit
BLM18BD421SN1□	420ohm±25%	200mA	0.55ohm max.	-55°C to +125°C	Kit
BLM18BD471SN1□	470ohm±25%	200mA	0.55ohm max.	-55°C to +125°C	Kit
BLM18BD601SN1□	600ohm±25%	200mA	0.65ohm max.	-55°C to +125°C	Kit
BLM18BD102SN1□	1000ohm±25%	100mA	0.85ohm max.	-55°C to +125°C	Kit
BLM18BD152SN1□	1500ohm±25%	50mA	1.20ohm max.	-55°C to +125°C	Kit
BLM18BD182SN1□	1800ohm±25%	50mA	1.50ohm max.	-55°C to +125°C	Kit
BLM18BD222SN1□	2200ohm±25%	50mA	1.50ohm max.	-55°C to +125°C	Kit
BLM18BD252SN1□	2500ohm±25%	50mA	1.50ohm max.	-55°C to +125°C	Kit
BLM18BB050SN1□	5ohm±25%	700mA	0.05ohm max.	-55°C to +125°C	Kit
BLM18BB100SN1□	10ohm±25%	700mA	0.10ohm max.	-55°C to +125°C	Kit
BLM18BB220SN1□	22ohm±25%	600mA	0.20ohm max.	-55°C to +125°C	Kit
BLM18BB470SN1□	47ohm±25%	550mA	0.25ohm max.	-55°C to +125°C	Kit
BLM18BB600SN1□	60ohm±25%	550mA	0.25ohm max.	-55°C to +125°C	Kit
BLM18BB750SN1□	75ohm±25%	500mA	0.30ohm max.	-55°C to +125°C	Kit
BLM18BB121SN1□	120ohm±25%	500mA	0.30ohm max.	-55°C to +125°C	Kit
BLM18BB141SN1□	140ohm±25%	450mA	0.35ohm max.	-55°C to +125°C	
BLM18BB151SN1□	150ohm±25%	450mA	0.37ohm max.	-55°C to +125°C	Kit
BLM18BB221SN1□	220ohm±25%	450mA	0.45ohm max.	-55°C to +125°C	Kit
BLM18BB331SN1□	330ohm±25%	400mA	0.58ohm max.	-55°C to +125°C	Kit
BLM18BB471SN1□	470ohm±25%	300mA	0.85ohm max.	-55°C to +125°C	Kit
BLM18BA050SN1□	5ohm±25%	500mA	0.20ohm max.	-55°C to +125°C	Kit
BLM18BA100SN1□	10ohm±25%	500mA	0.25ohm max.	-55°C to +125°C	Kit
BLM18BA220SN1□	22ohm±25%	500mA	0.35ohm max.	-55°C to +125°C	
BLM18BA470SN1□	47ohm±25%	300mA	0.55ohm max.	-55°C to +125°C	Kit
BLM18BA750SN1□	75ohm±25%	300mA	0.70ohm max.	-55°C to +125°C	Kit
BLM18BA121SN1□	120ohm±25%	200mA	0.90ohm max.	-55°C to +125°C	Kit

Number of Circuits: 1

Continued on the following page.

⚠Note • Please read rating and ⚠CAUTION (for storage, operating, rating, soldering, mounting and handling) in this catalog to prevent smoking and/or burning, etc.  
 • This catalog has only typical specifications because there is no space for detailed specifications. Therefore, please review our product specifications or consult the approval sheet for product specifications before ordering.

Impedance-Frequency Characteristics (Main Items)

BLM18BD Series (47ohm to 420ohm)

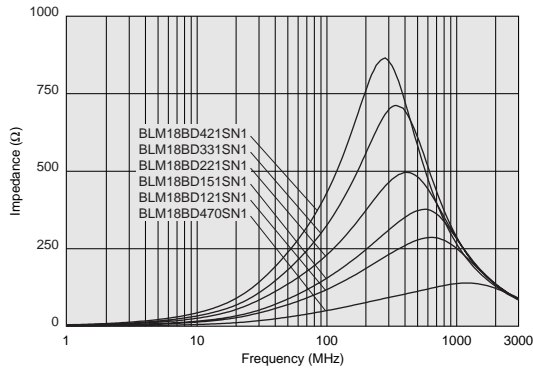

BLM18BD Series (470ohm to 2500ohm)

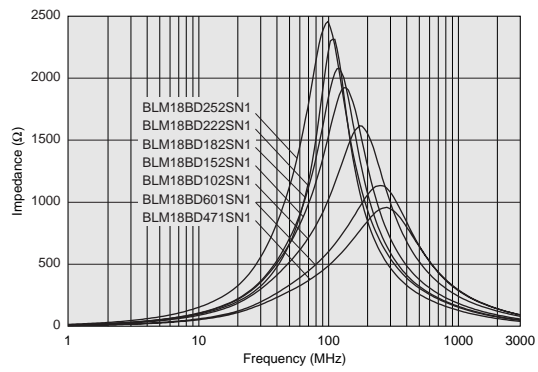

BLM18BB Series (5ohm to 75ohm)

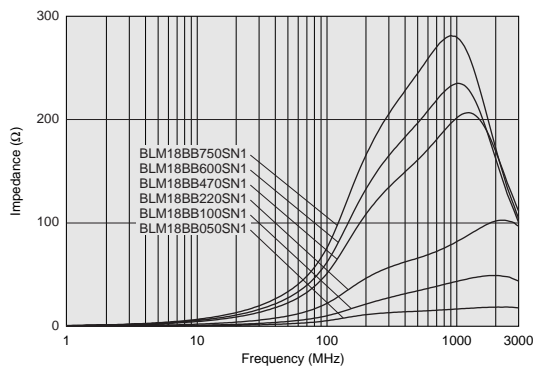

BLM18BB Series (120ohm to 470ohm)

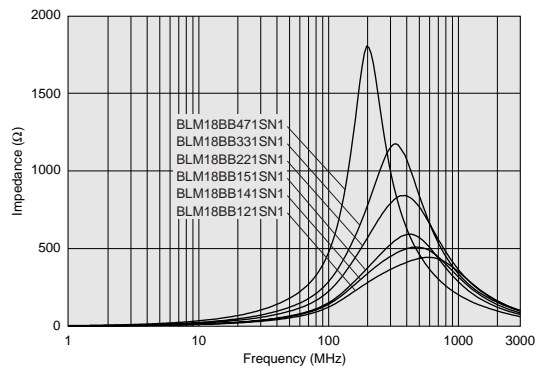

BLM18BA Series (5ohm to 22ohm)

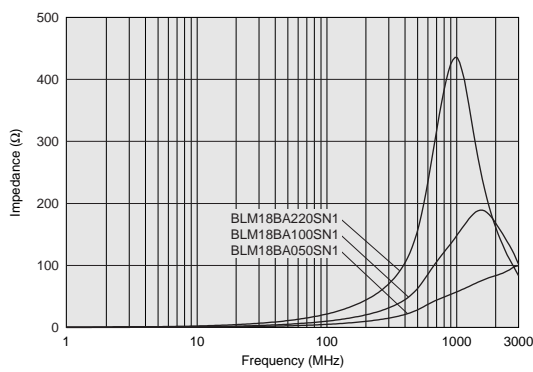

BLM18BA Series (47ohm to 120ohm)

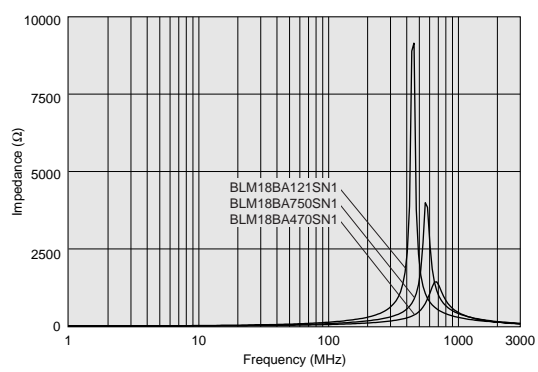

Impedance-Frequency Characteristics

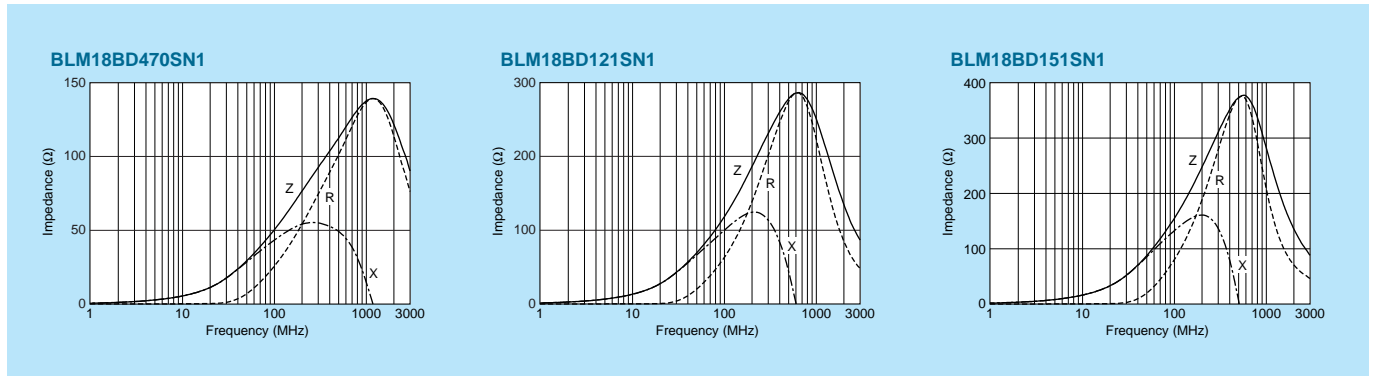

Continued on the following page.

⚠Note • Please read rating and ⚠CAUTION (for storage, operating, rating, soldering, mounting and handling) in this catalog to prevent smoking and/or burning, etc.  
 • This catalog has only typical specifications because there is no space for detailed specifications. Therefore, please review our product specifications or consult the approval sheet for product specifications before ordering.

Impedance-Frequency Characteristics

BLM18BD221SN1

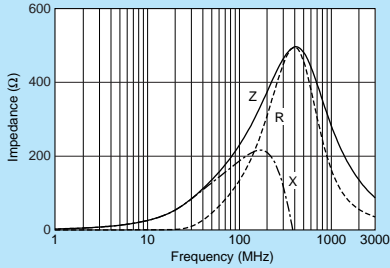

BLM18BD331SN1

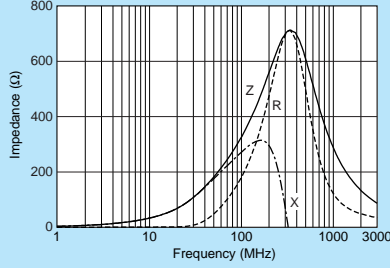

BLM18BD421SN1

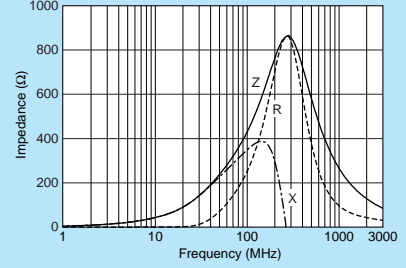

BLM18BD471SN1

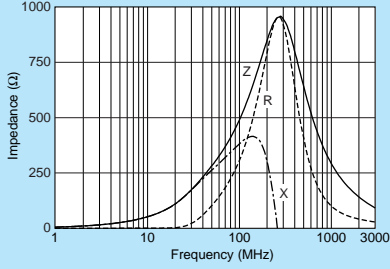

BLM18BD601SN1

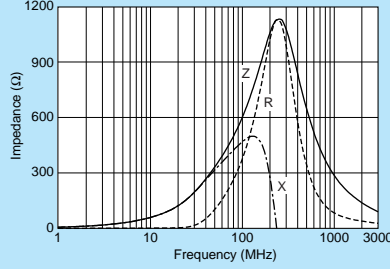

BLM18BD102SN1

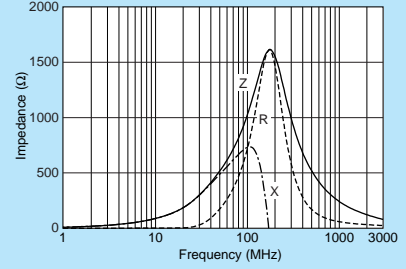

BLM18BD152SN1

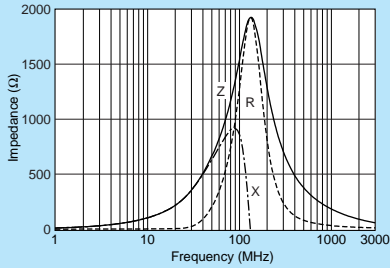

BLM18BD182SN1

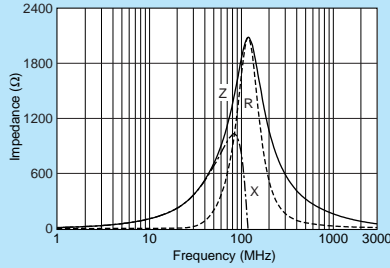

BLM18BD222SN1

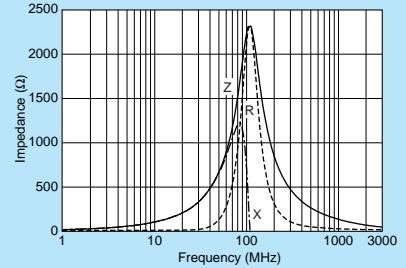

BLM18BD252SN1

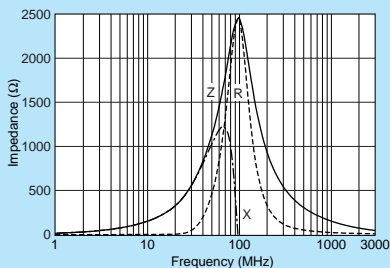

BLM18BB050SN1

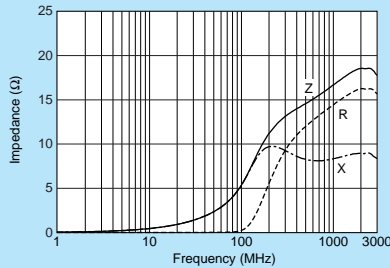

BLM18BB100SN1

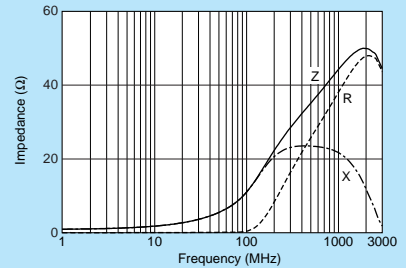

BLM18BB220SN1

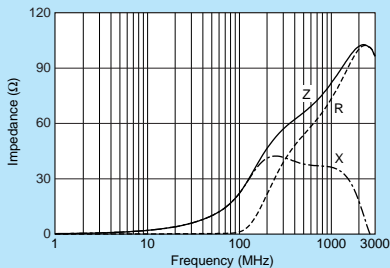

BLM18BB470SN1

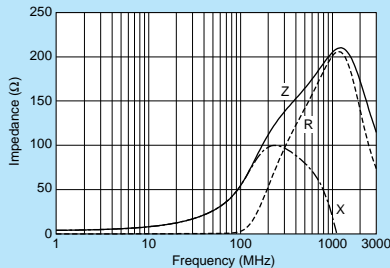

BLM18BB600SN1

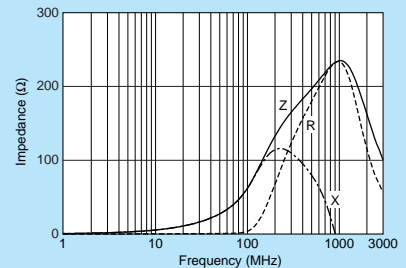

Continued on the following page.

Note: Please read rating and CAUTION (for storage, operating, rating, soldering, mounting and handling) in this catalog to prevent smoking and/or burning, etc.  
 This catalog has only typical specifications because there is no space for detailed specifications. Therefore, please review our product specifications or consult the approval sheet for product specifications before ordering.

Impedance-Frequency Characteristics

Chip Ferrite Bead  
 Signal Lines Type

Chip EMIFIL®

Chip Common Mode Choke Coil

Block Type EMIFIL®

BLM18BB750SN1

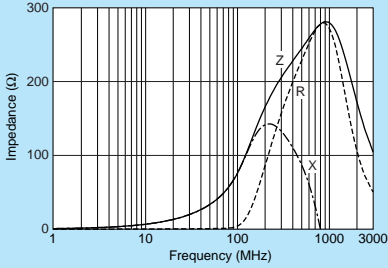

BLM18BB121SN1

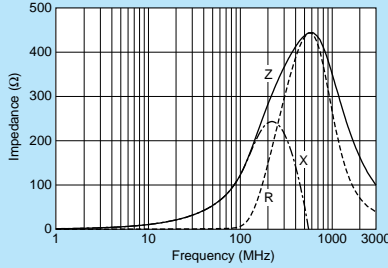

BLM18BB141SN1

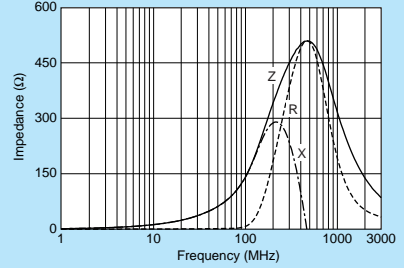

BLM18BB151SN1

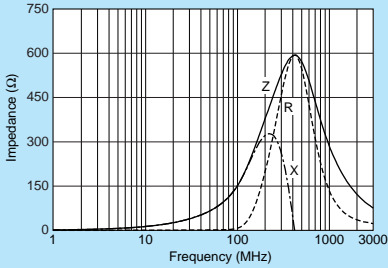

BLM18BB221SN1

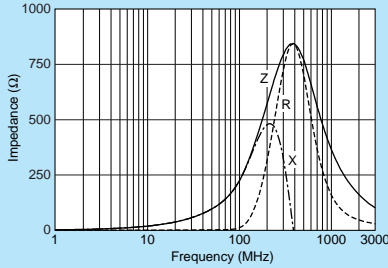

BLM18BB331SN1

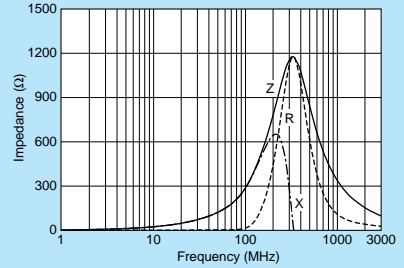

BLM18BB471SN1

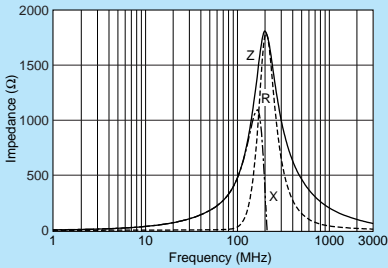

BLM18BA050SN1

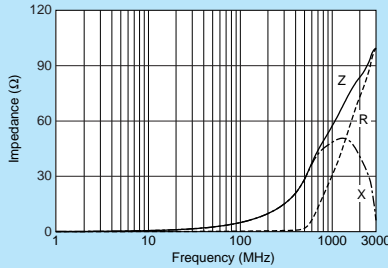

BLM18BA100SN1

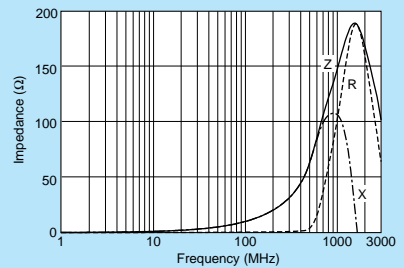

BLM18BA220SN1

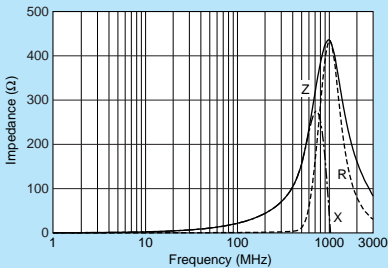

BLM18BA470SN1

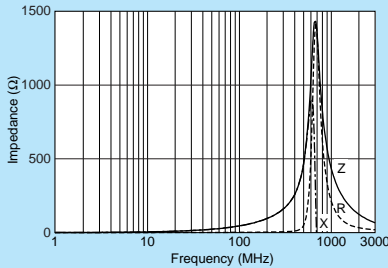

BLM18BA750SN1

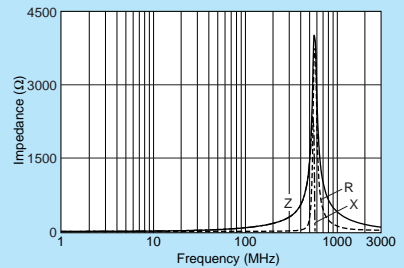

BLM18BA121SN1

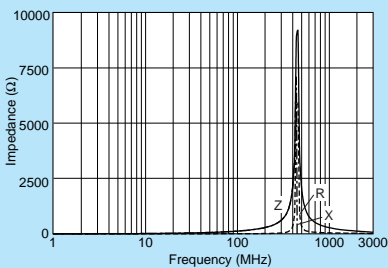

⚠Note • Please read rating and ⚠CAUTION (for storage, operating, rating, soldering, mounting and handling) in this catalog to prevent smoking and/or burning, etc.  
 • This catalog has only typical specifications because there is no space for detailed specifications. Therefore, please review our product specifications or consult the approval sheet for product specifications before ordering.

# BLM21B Series (0805 Size)



0805 size for high speed signal lines.

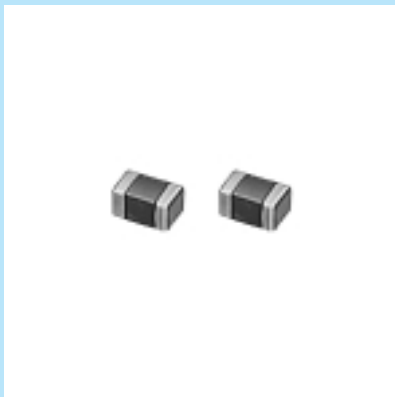

### ■ Dimensions

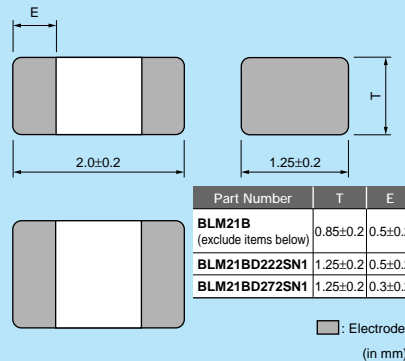

### ■ Equivalent Circuit

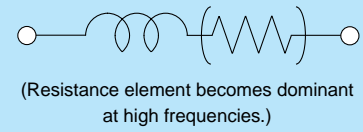

### ■ Packaging

• All except BLM21BD222SN1/21BD272SN1

Code	Packaging	Minimum Quantity
D	180mm Reel Paper Tape	4000
J	330mm Reel Paper Tape	10000
B	Bulk(Bag)	1000

• BLM21BD222SN1/21BD272SN1 only

Code	Packaging	Minimum Quantity
L	180mm Reel Plastic Tape	3000
K	330mm Reel Plastic Tape	10000
B	Bulk(Bag)	1000

Refer to pages from p.91 to p.94 for mounting information.

### ■ Rated Value (□: packaging code)

Part Number	Impedance (at 100MHz/20°C)	Rated Current	DC Resistance	Operating Temperature Range	
BLM21BD121SN1□	120ohm±25%	200mA	0.25ohm max.	-55°C to +125°C	Kit
BLM21BD151SN1□	150ohm±25%	200mA	0.25ohm max.	-55°C to +125°C	
BLM21BD221SN1□	220ohm±25%	200mA	0.25ohm max.	-55°C to +125°C	Kit
BLM21BD331SN1□	330ohm±25%	200mA	0.30ohm max.	-55°C to +125°C	
BLM21BD421SN1□	420ohm±25%	200mA	0.30ohm max.	-55°C to +125°C	Kit
BLM21BD471SN1□	470ohm±25%	200mA	0.35ohm max.	-55°C to +125°C	Kit
BLM21BD601SN1□	600ohm±25%	200mA	0.35ohm max.	-55°C to +125°C	Kit
BLM21BD751SN1□	750ohm±25%	200mA	0.40ohm max.	-55°C to +125°C	
BLM21BD102SN1□	1000ohm±25%	200mA	0.40ohm max.	-55°C to +125°C	Kit
BLM21BD152SN1□	1500ohm±25%	200mA	0.45ohm max.	-55°C to +125°C	Kit
BLM21BD182SN1□	1800ohm±25%	200mA	0.50ohm max.	-55°C to +125°C	Kit
BLM21BD222TN1□	2200ohm±25%	200mA	0.60ohm max.	-55°C to +125°C	Kit
BLM21BD222SN1□	2250ohm(Typ.)	200mA	0.60ohm max.	-55°C to +125°C	Kit
BLM21BD272SN1□	2700ohm±25%	200mA	0.80ohm max.	-55°C to +125°C	Kit
BLM21BB050SN1□	5ohm±25%	500mA	0.07ohm max.	-55°C to +125°C	Kit
BLM21BB600SN1□	60ohm±25%	200mA	0.20ohm max.	-55°C to +125°C	Kit
BLM21BB750SN1□	75ohm±25%	200mA	0.25ohm max.	-55°C to +125°C	Kit
BLM21BB121SN1□	120ohm±25%	200mA	0.25ohm max.	-55°C to +125°C	Kit
BLM21BB151SN1□	150ohm±25%	200mA	0.25ohm max.	-55°C to +125°C	
BLM21BB201SN1□	200ohm±25%	200mA	0.35ohm max.	-55°C to +125°C	
BLM21BB221SN1□	220ohm±25%	200mA	0.35ohm max.	-55°C to +125°C	Kit
BLM21BB331SN1□	330ohm±25%	200mA	0.40ohm max.	-55°C to +125°C	Kit
BLM21BB471SN1□	470ohm±25%	200mA	0.45ohm max.	-55°C to +125°C	Kit

Number of Circuits: 1

Continued on the following page. ↗

△Note • Please read rating and △CAUTION (for storage, operating, rating, soldering, mounting and handling) in this catalog to prevent smoking and/or burning, etc.  
• This catalog has only typical specifications because there is no space for detailed specifications. Therefore, please review our product specifications or consult the approval sheet for product specifications before ordering.



Impedance-Frequency Characteristics (Main Items)

BLM21BD Series

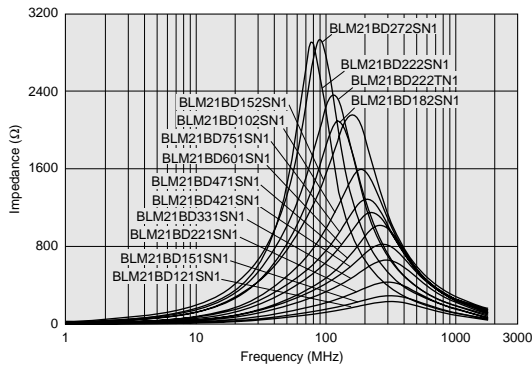

BLM21BB Series

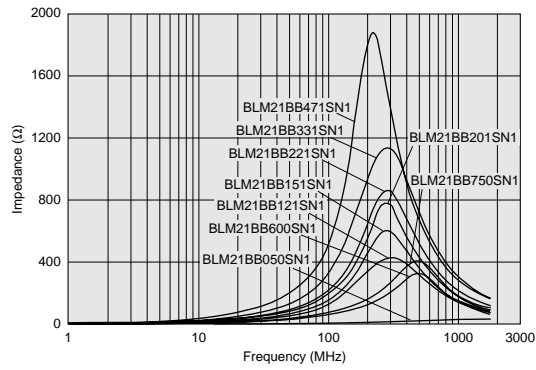

Impedance-Frequency Characteristics

BLM21BD121SN1

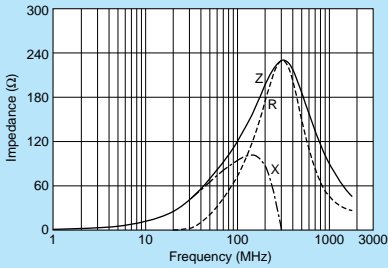

BLM21BD151SN1

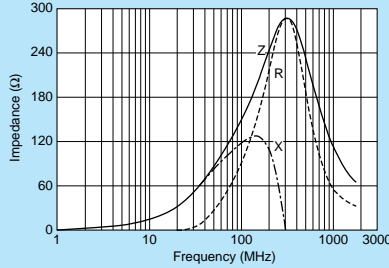

BLM21BD221SN1

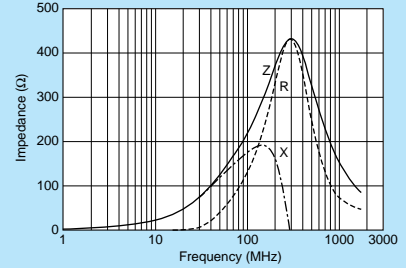

BLM21BD331SN1

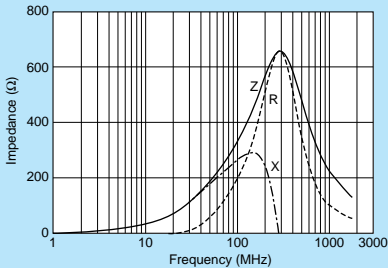

BLM21BD421SN1

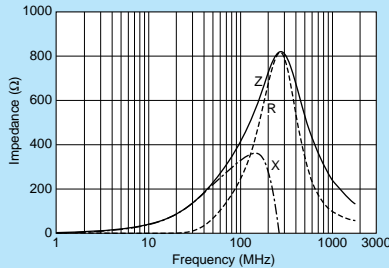

BLM21BD471SN1

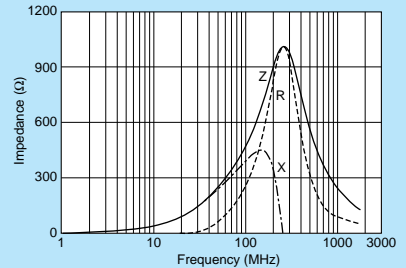

BLM21BD601SN1

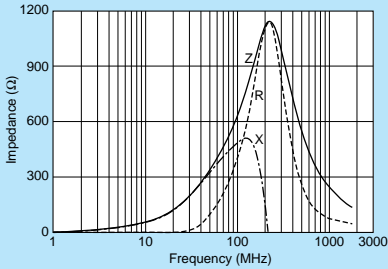

BLM21BD751SN1

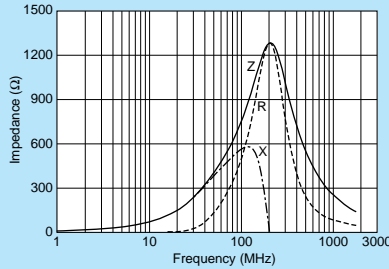

BLM21BD102SN1

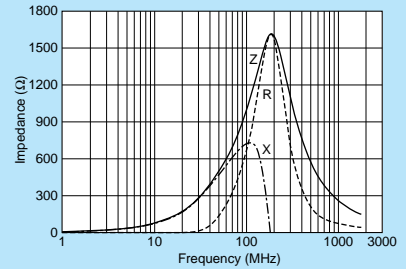

Continued on the following page. ↗

△Note • Please read rating and △CAUTION (for storage, operating, rating, soldering, mounting and handling) in this catalog to prevent smoking and/or burning, etc.  
 • This catalog has only typical specifications because there is no space for detailed specifications. Therefore, please review our product specifications or consult the approval sheet for product specifications before ordering.

Impedance-Frequency Characteristics

BLM21BD152SN1

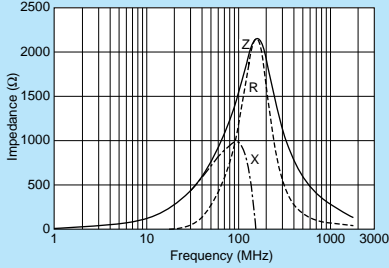

BLM21BD182SN1

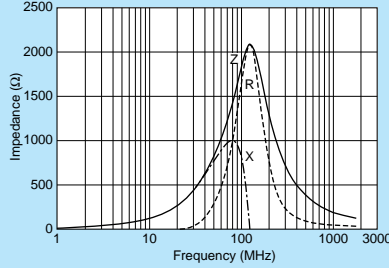

BLM21BD222TN1

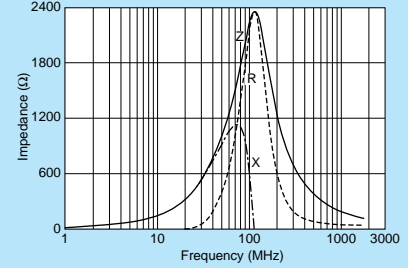

BLM21BD222SN1

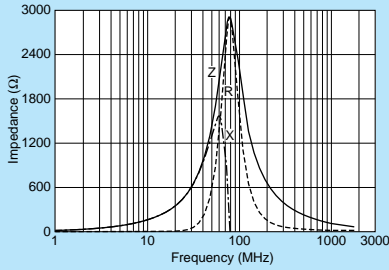

BLM21BD272SN1

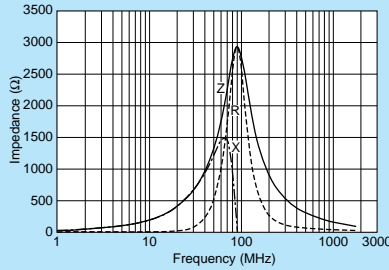

BLM21BB050SN1

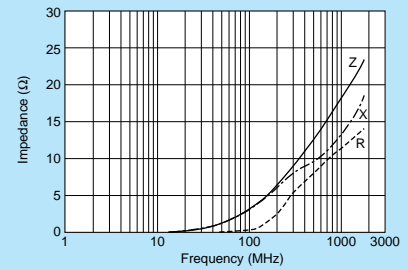

BLM21BB600SN1

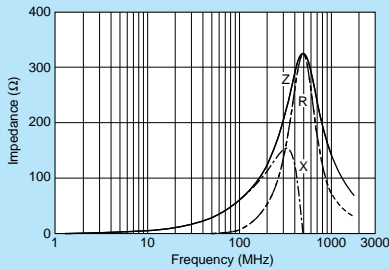

BLM21BB750SN1

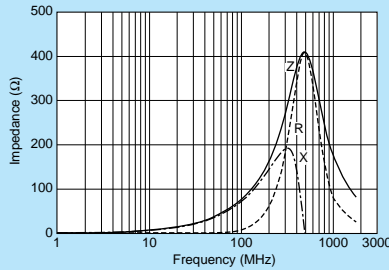

BLM21BB121SN1

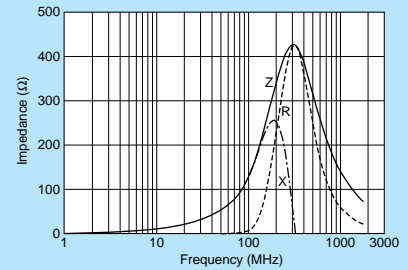

BLM21BB151SN1

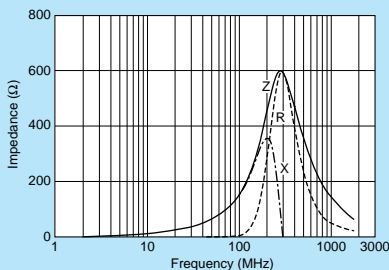

BLM21BB201SN1

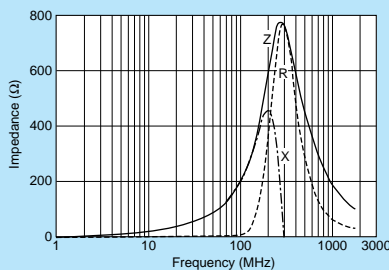

BLM21BB221SN1

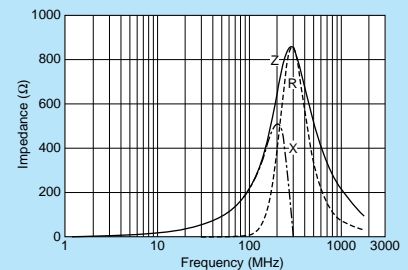

BLM21BB331SN1

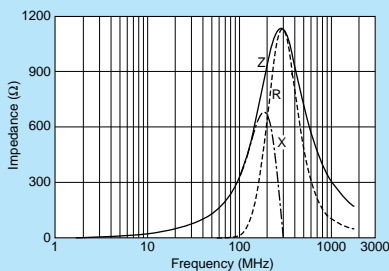

BLM21BB471SN1

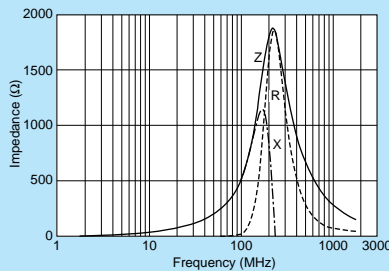

Note • Please read rating and CAUTION (for storage, operating, rating, soldering, mounting and handling) in this catalog to prevent smoking and/or burning, etc.  
 • This catalog has only typical specifications because there is no space for detailed specifications. Therefore, please review our product specifications or consult the approval sheet for product specifications before ordering.

# BLM18R Series (0603 Size)



For digital I/F. Reduce the distortion of waveform created by resonance.

Chip Ferrite Bead  
Signal Lines Type



### ■ Dimensions

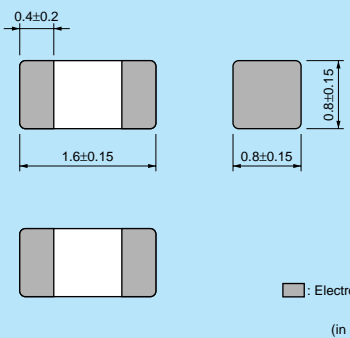

(in mm)

### ■ Equivalent Circuit



(Resistance element becomes dominant at high frequencies.)

### ■ Packaging

Code	Packaging	Minimum Quantity
D	180mm Reel Paper Tape	4000
J	330mm Reel Paper Tape	10000
B	Bulk(Bag)	1000

Refer to pages from p.91 to p.94 for mounting information.

### ■ Rated Value (□: packaging code)

Part Number	Impedance (at 100MHz/20°C)	Rated Current	DC Resistance	Operating Temperature Range	
BLM18RK121SN1□	120ohm±25%	200mA	0.25ohm max.	-55°C to +125°C	Kit
BLM18RK221SN1□	220ohm±25%	200mA	0.30ohm max.	-55°C to +125°C	
BLM18RK471SN1□	470ohm±25%	200mA	0.50ohm max.	-55°C to +125°C	Kit
BLM18RK601SN1□	600ohm±25%	200mA	0.60ohm max.	-55°C to +125°C	Kit
BLM18RK102SN1□	1000ohm±25%	200mA	0.80ohm max.	-55°C to +125°C	Kit

Number of Circuits: 1

### ■ Impedance-Frequency Characteristics (Main Items)

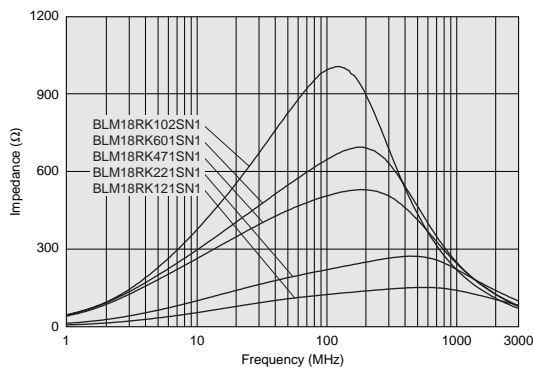

Chip Common Mode Choke Coil

### ■ Impedance-Frequency Characteristics

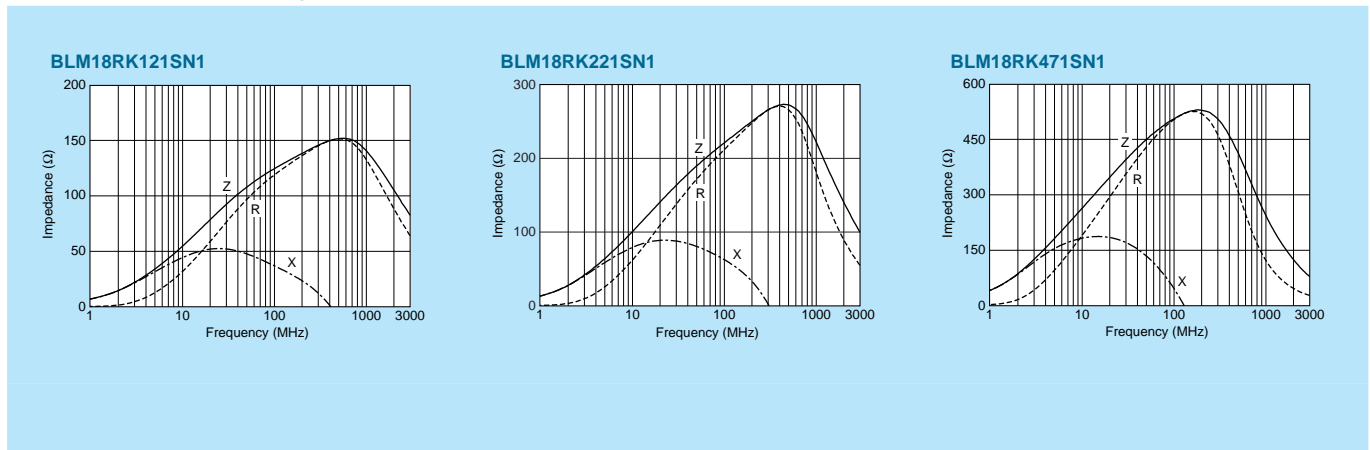

Continued on the following page.

**Note** • Please read rating and **CAUTION** (for storage, operating, rating, soldering, mounting and handling) in this catalog to prevent smoking and/or burning, etc.  
• This catalog has only typical specifications because there is no space for detailed specifications. Therefore, please review our product specifications or consult the approval sheet for product specifications before ordering.

■ Impedance-Frequency Characteristics

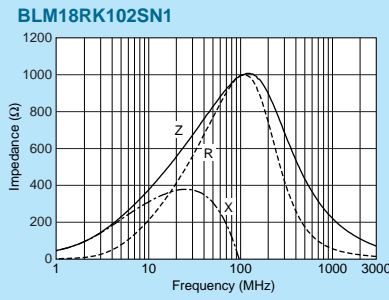
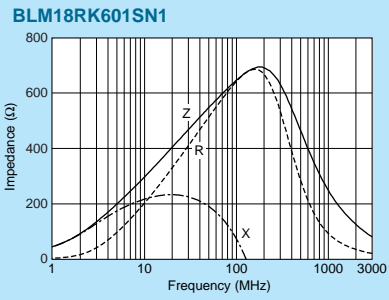

Signal Lines Type  
Chip Ferrite Bead

Chip EMIFIL®

Chip Common Mode Choke Coil

Block Type EMIFIL®

△Note • Please read rating and △CAUTION (for storage, operating, rating, soldering, mounting and handling) in this catalog to prevent smoking and/or burning, etc.  
 • This catalog has only typical specifications because there is no space for detailed specifications. Therefore, please review our product specifications or consult the approval sheet for product specifications before ordering.

# BLM21R Series (0805 Size)



For digital I/F. Reduce the distortion of waveform created by resonance.

Chip Ferrite Bead  
Signal Lines Type

Chip EMIFIL®

Chip Common Mode Choke Coil

Block Type EMIFIL®



### ■ Dimensions

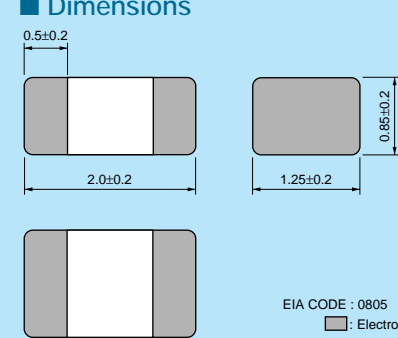

EIA CODE : 0805  
 Electrode  
 (in mm)

### ■ Equivalent Circuit



(Resistance element becomes dominant at high frequencies.)

### ■ Packaging

Code	Packaging	Minimum Quantity
D	180mm Reel Paper Tape	4000
J	330mm Reel Paper Tape	10000
B	Bulk(Bag)	1000

Refer to pages from p.91 to p.94 for mounting information.

### ■ Rated Value (□: packaging code)

Part Number	Impedance (at 100MHz/20°C)	Rated Current	DC Resistance	Operating Temperature Range
BLM21RK121SN1□	120ohm±25%	200mA	0.15ohm max.	-55°C to +125°C
BLM21RK221SN1□	220ohm±25%	200mA	0.20ohm max.	-55°C to +125°C
BLM21RK471SN1□	470ohm±25%	200mA	0.25ohm max.	-55°C to +125°C
BLM21RK601SN1□	600ohm±25%	200mA	0.30ohm max.	-55°C to +125°C
BLM21RK102SN1□	1000ohm±25%	200mA	0.50ohm max.	-55°C to +125°C

Number of Circuits: 1

### ■ Impedance-Frequency Characteristics (Main Items)

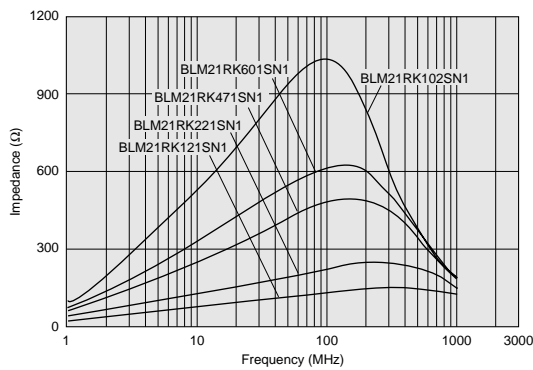

### ■ Impedance-Frequency Characteristics

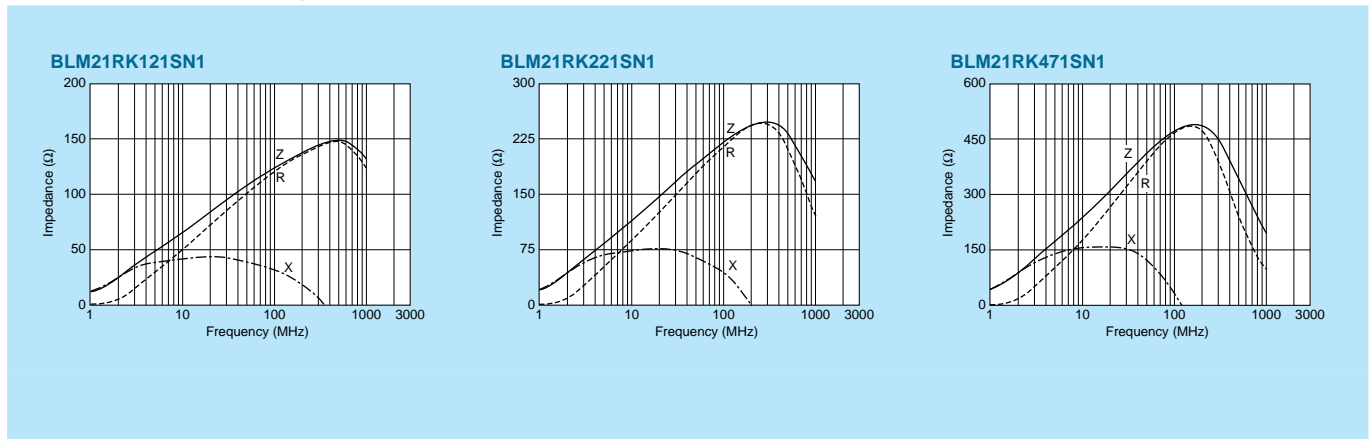

Continued on the following page.

△Note • Please read rating and △CAUTION (for storage, operating, rating, soldering, mounting and handling) in this catalog to prevent smoking and/or burning, etc.  
 • This catalog has only typical specifications because there is no space for detailed specifications. Therefore, please review our product specifications or consult the approval sheet for product specifications before ordering.

■ Impedance-Frequency Characteristics

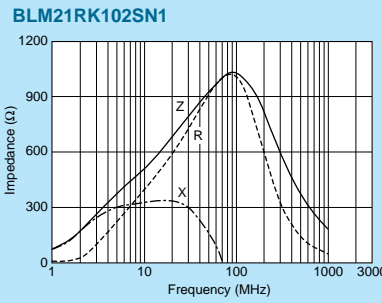
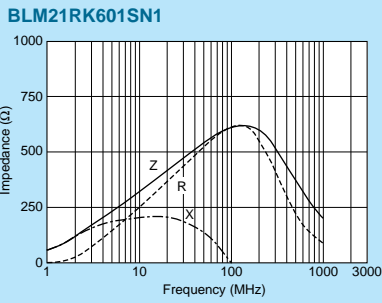

Signal Lines Type  
Chip Ferrite Bead

Chip EMIFIL®

Chip Common Mode Choke Coil

Block Type EMIFIL®

⚠Note • Please read rating and ⚠CAUTION (for storage, operating, rating, soldering, mounting and handling) in this catalog to prevent smoking and/or burning, etc.  
 • This catalog has only typical specifications because there is no space for detailed specifications. Therefore, please review our product specifications or consult the approval sheet for product specifications before ordering.

# Waveform Distortion Suppressing Performance of BLM□□R Series

## Measuring Circuits

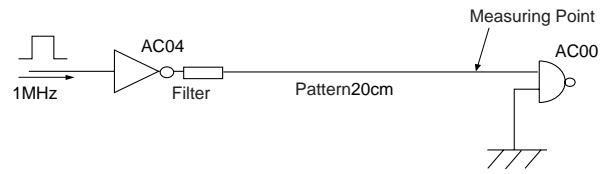

### Type of Filter

### EMI Suppression Effect / Description

Initial  
(No filter)

Signal waveform (100nsec/div, 2V/div)

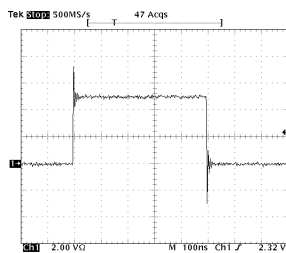

Expand (10nsec/div, 2V/div)

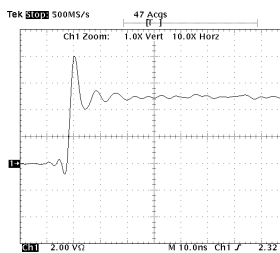

Spectrum

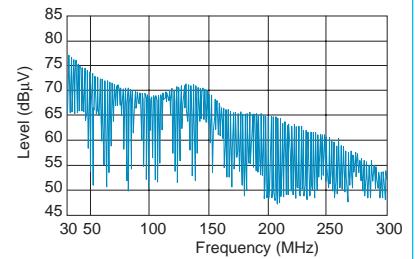

Ringing is caused on the signal waveform.  
Such ringing contains several hundred MHz harmonic components and generates noise.

Resistor (47Ω)  
is used

Signal waveform (100nsec/div, 2V/div)

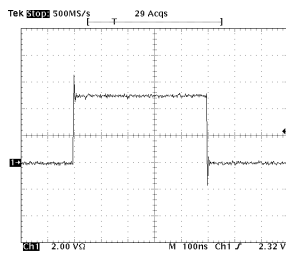

Expand (10nsec/div, 2V/div)

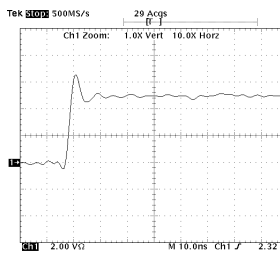

Spectrum

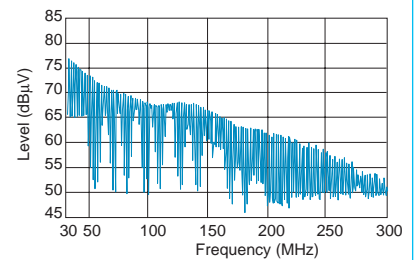

Comparing initial waveform, ringing is suppressed a little.  
However there still remains high level waveform distortion.

BLM18RK221SN1  
(220Ω at 100MHz)  
is used

Signal waveform (100nsec/div, 2V/div)

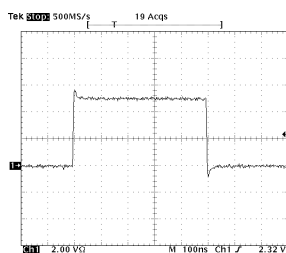

Expand (10nsec/div, 2V/div)

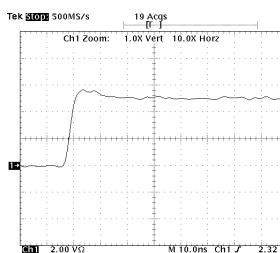

Spectrum

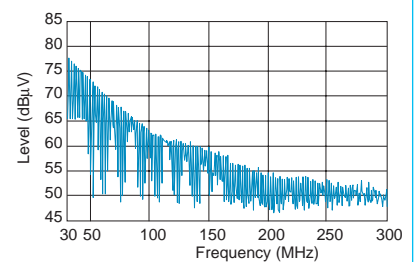

BLM18R has excellent performance for noise suppression and waveform distortion suppression.  
BLM18R suppresses drastically not only spectrum level in more than 100MHz range but waveform distortion.

△Note • Please read rating and △CAUTION (for storage, operating, rating, soldering, mounting and handling) in this catalog to prevent smoking and/or burning, etc.  
• This catalog has only typical specifications because there is no space for detailed specifications. Therefore, please review our product specifications or consult the approval sheet for product specifications before ordering.

# BLM03H Series (0201 Size)



0201 size for GHz band noise.

### ■ Dimensions

■: Electrode  
(in mm)

### ■ Equivalent Circuit

(Resistance element becomes dominant at high frequencies.)

### ■ Packaging

Code	Packaging	Minimum Quantity
D	180mm Reel Paper Tape	15000
J	330mm Reel Paper Tape	50000
B	Bulk(Bag)	1000

Refer to pages from p.91 to p.94 for mounting information.

### ■ Rated Value (□: packaging code)

Part Number	Impedance (at 100MHz/20°C)	Impedance (at 1GHz/20°C)	Rated Current	DC Resistance	Operating Temperature Range	
BLM03HG601SN1□	600ohm±25%	1000ohm±40%	150mA	1.6ohm max.	-55°C to +125°C	<b>Kit</b>
BLM03HG102SN1□	1000ohm±25%	1800ohm±40%	125mA	2.6ohm max.	-55°C to +125°C	<b>Kit</b>
BLM03HD331SN1□	330ohm±25%	750ohm±40%	200mA	1.0ohm max.	-55°C to +125°C	<b>New Kit</b>
BLM03HD471SN1□	470ohm±25%	1000ohm±40%	175mA	1.3ohm max.	-55°C to +125°C	<b>New Kit</b>
BLM03HD601SN1□	600ohm±25%	1500ohm±40%	150mA	1.7ohm max.	-55°C to +125°C	<b>New Kit</b>
BLM03HD102SN1□	1000ohm±25%	2300ohm±40%	120mA	2.9ohm max.	-55°C to +125°C	<b>New Kit</b>

Number of Circuits: 1

### ■ Impedance-Frequency Characteristics (Main Items)

#### BLM03HG Series

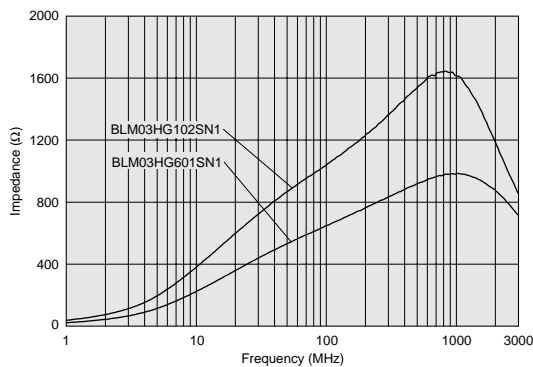

#### BLM03HD Series

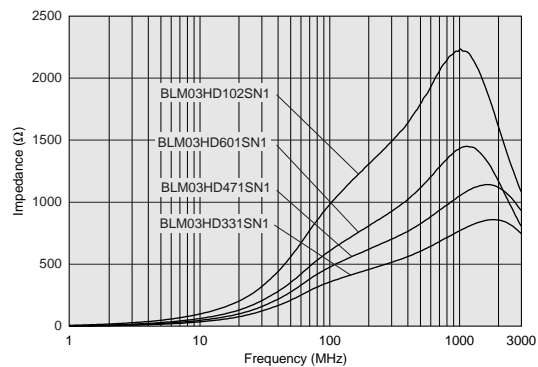

### ■ Impedance-Frequency Characteristics

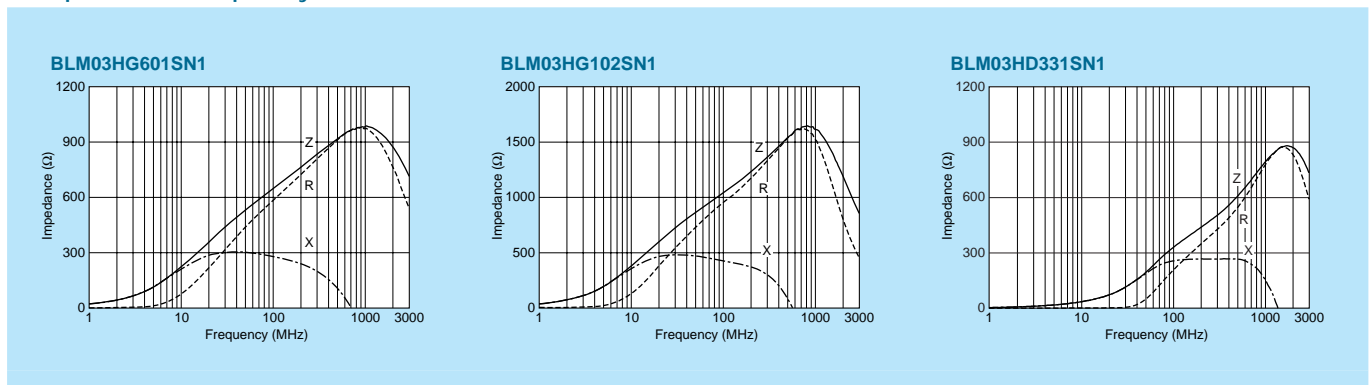

Continued on the following page.

△Note • Please read rating and △CAUTION (for storage, operating, rating, soldering, mounting and handling) in this catalog to prevent smoking and/or burning, etc.  
 • This catalog has only typical specifications because there is no space for detailed specifications. Therefore, please review our product specifications or consult the approval sheet for product specifications before ordering.



Impedance-Frequency Characteristics

Chip Ferrite Bead  
 Signal Lines Type

Chip EMIFIL®

Chip Common Mode Choke Coil

Block Type EMIFIL®

BLM03HD471SN1

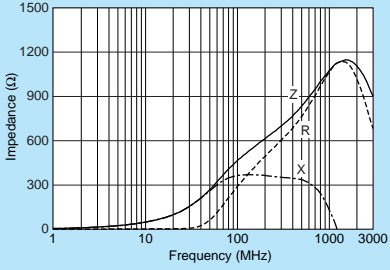

BLM03HD601SN1

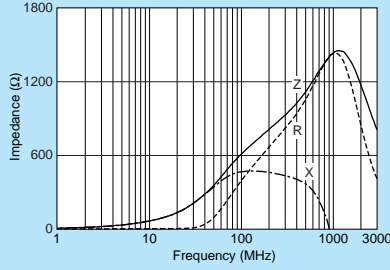

BLM03HD102SN1

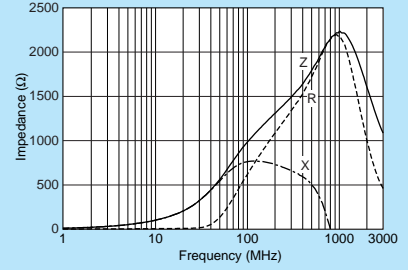

△Note • Please read rating and △CAUTION (for storage, operating, rating, soldering, mounting and handling) in this catalog to prevent smoking and/or burning, etc.  
 • This catalog has only typical specifications because there is no space for detailed specifications. Therefore, please review our product specifications or consult the approval sheet for product specifications before ordering.

# BLM15H Series (0402 Size)



0402 size for GHz band noise.

### ■ Dimensions

### ■ Equivalent Circuit

(Resistance element becomes dominant at high frequencies.)

### ■ Packaging

Code	Packaging	Minimum Quantity
D	180mm Reel Paper Tape	10000
J	330mm Reel Paper Tape	50000
B	Bulk(Bag)	1000

Refer to pages from p.91 to p.94 for mounting information.

### ■ Rated Value (□: packaging code)

Part Number	Impedance (at 100MHz/20°C)	Impedance (at 1GHz/20°C)	Rated Current	DC Resistance	Operating Temperature Range	
BLM15HG601SN1□	600ohm±25%	1000ohm±40%	300mA	0.7ohm max.	-55°C to +125°C	Kit
BLM15HG102SN1□	1000ohm±25%	1400ohm±40%	250mA	1.1ohm max.	-55°C to +125°C	Kit
BLM15HD601SN1□	600ohm±25%	1400ohm±40%	300mA	0.85ohm max.	-55°C to +125°C	Kit
BLM15HD102SN1□	1000ohm±25%	2000ohm±40%	250mA	1.25ohm max.	-55°C to +125°C	Kit
BLM15HD182SN1□	1800ohm±25%	2700ohm±40%	200mA	2.2ohm max.	-55°C to +125°C	Kit
BLM15HB121SN1□	120ohm±25%	500ohm±40%	300mA	0.7ohm max.	-55°C to +125°C	Kit
BLM15HB221SN1□	220ohm±25%	900ohm±40%	250mA	1.0ohm max.	-55°C to +125°C	Kit

Number of Circuits: 1

### ■ Impedance-Frequency Characteristics (Main Items)

#### BLM15HG Series (For General Signal Lines)

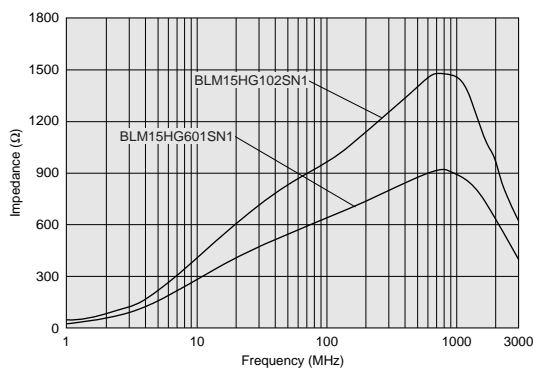

#### BLM15HD Series (For High Speed Signal Lines)

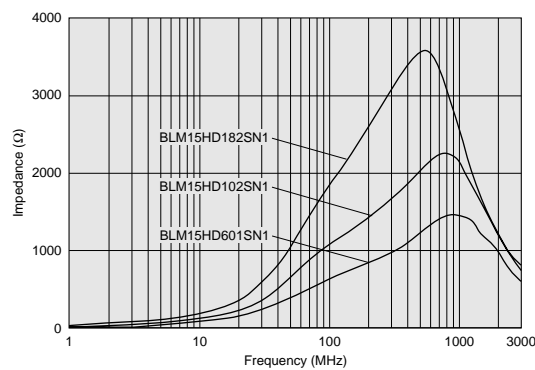

#### BLM15HB Series (For High Speed Signal Lines)

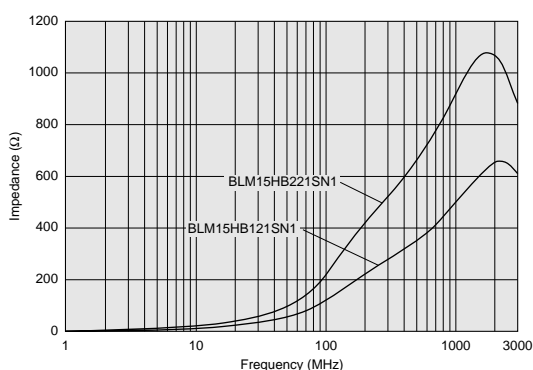

Continued on the following page. ↗

△Note • Please read rating and △CAUTION (for storage, operating, rating, soldering, mounting and handling) in this catalog to prevent smoking and/or burning, etc.  
 • This catalog has only typical specifications because there is no space for detailed specifications. Therefore, please review our product specifications or consult the approval sheet for product specifications before ordering.

Impedance-Frequency Characteristics

Chip Ferrite Bead  
 Signal Lines Type

Chip EMIFIL®

Chip Common Mode Choke Coil

Block Type EMIFIL®

BLM15HG601SN1

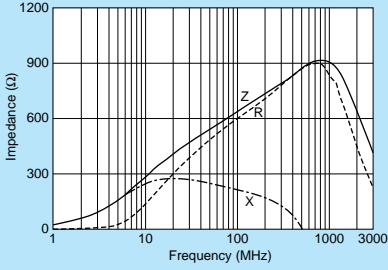

BLM15HG102SN1

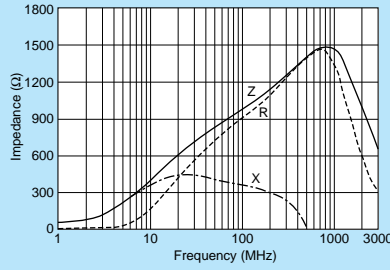

BLM15HD601SN1

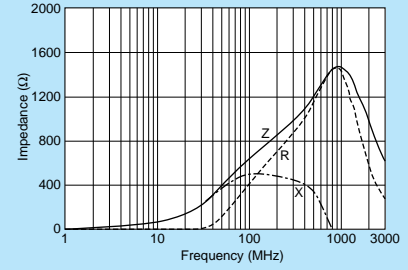

BLM15HD102SN1

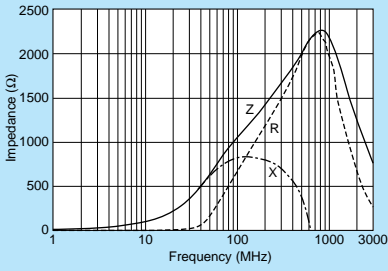

BLM15HD182SN1

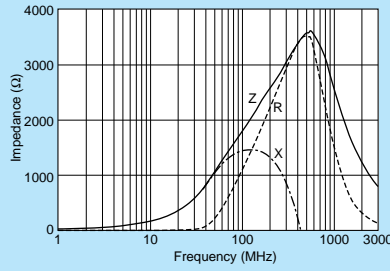

BLM15HB121SN1

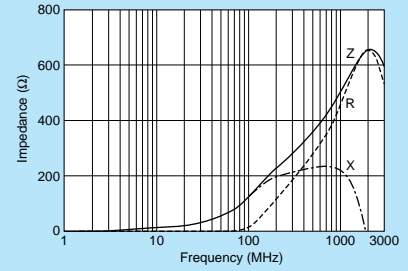

BLM15HB221SN1

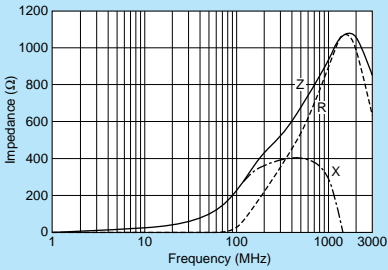

△Note • Please read rating and △CAUTION (for storage, operating, rating, soldering, mounting and handling) in this catalog to prevent smoking and/or burning, etc.  
 • This catalog has only typical specifications because there is no space for detailed specifications. Therefore, please review our product specifications or consult the approval sheet for product specifications before ordering.

# BLM18H Series (0603 Size)



## 0603 size for GHz band noise.

\*Please refer to BLM15H for downsizing.

### ■ Dimensions

(in mm)

### ■ Equivalent Circuit

(Resistance element becomes dominant at high frequencies.)

### ■ Packaging

Code	Packaging	Minimum Quantity
D	180mm Reel Paper Tape	4000
J	330mm Reel Paper Tape	10000
B	Bulk(Bag)	1000

Refer to pages from p.91 to p.94 for mounting information.

### ■ Rated Value (□: packaging code)

Part Number	Impedance (at 100MHz/20°C)	Impedance (at 1GHz/20°C)	Rated Current	DC Resistance	Operating Temperature Range	
BLM18HG471SN1□	470ohm±25%	600ohm(Typ.)	200mA	0.85ohm max.	-55°C to +125°C	Kit
BLM18HG601SN1□	600ohm±25%	700ohm(Typ.)	200mA	1.00ohm max.	-55°C to +125°C	Kit
BLM18HG102SN1□	1000ohm±25%	1000ohm(Typ.)	100mA	1.60ohm max.	-55°C to +125°C	Kit
BLM18HE601SN1□	600ohm±25%	600ohm(Typ.)	800mA	0.25ohm max.	-55°C to +125°C	Kit
BLM18HE102SN1□	1000ohm±25%	1000ohm(Typ.)	600mA	0.35ohm max.	-55°C to +125°C	Kit
BLM18HE152SN1□	1500ohm±25%	1500ohm(Typ.)	500mA	0.50ohm max.	-55°C to +125°C	Kit
BLM18HD471SN1□	470ohm±25%	1000ohm(Typ.)	100mA	1.20ohm max.	-55°C to +125°C	Kit
BLM18HD601SN1□	600ohm±25%	1200ohm(Typ.)	100mA	1.50ohm max.	-55°C to +125°C	Kit
BLM18HD102SN1□	1000ohm±25%	1700ohm(Typ.)	50mA	1.80ohm max.	-55°C to +125°C	Kit
BLM18HB121SN1□	120ohm±25%	500ohm±40%	200mA	0.50ohm max.	-55°C to +125°C	Kit
BLM18HB221SN1□	220ohm±25%	1100ohm±40%	100mA	0.80ohm max.	-55°C to +125°C	Kit
BLM18HB331SN1□	330ohm±25%	1600ohm±40%	50mA	1.20ohm max.	-55°C to +125°C	Kit
BLM18HK331SN1□	330ohm±25%	400ohm±40%	200mA	0.50ohm max.	-55°C to +125°C	Kit
BLM18HK471SN1□	470ohm±25%	600ohm±40%	200mA	0.70ohm max.	-55°C to +125°C	Kit
BLM18HK601SN1□	600ohm±25%	700ohm±40%	100mA	0.90ohm max.	-55°C to +125°C	Kit
BLM18HK102SN1□	1000ohm±25%	1200ohm±40%	50mA	1.50ohm max.	-55°C to +125°C	Kit

Number of Circuits: 1

### ■ Impedance-Frequency Characteristics (Main Items)

#### BLM18HG Series (For General Signal Lines)

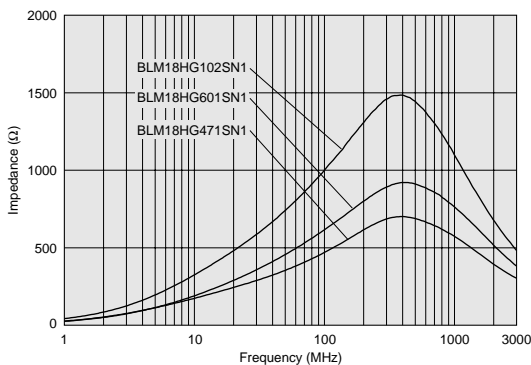

#### BLM18HE Series (For High Speed Signal Lines)

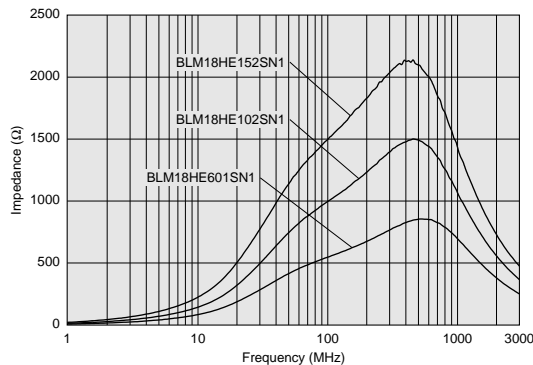

Continued on the following page.

△Note • Please read rating and △CAUTION (for storage, operating, rating, soldering, mounting and handling) in this catalog to prevent smoking and/or burning, etc.  
 • This catalog has only typical specifications because there is no space for detailed specifications. Therefore, please review our product specifications or consult the approval sheet for product specifications before ordering.

Impedance-Frequency Characteristics (Main Items)

BLM18HD Series (For High Speed Signal Lines)

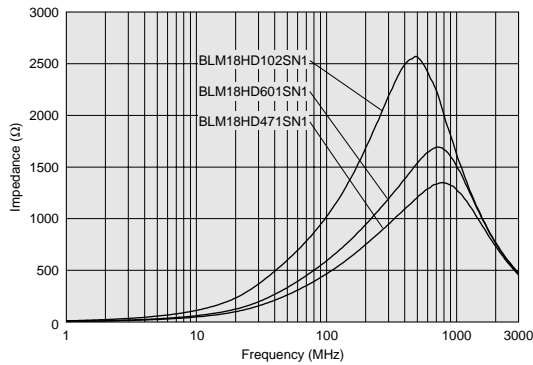

BLM18HB Series (For High Speed Signal Lines)

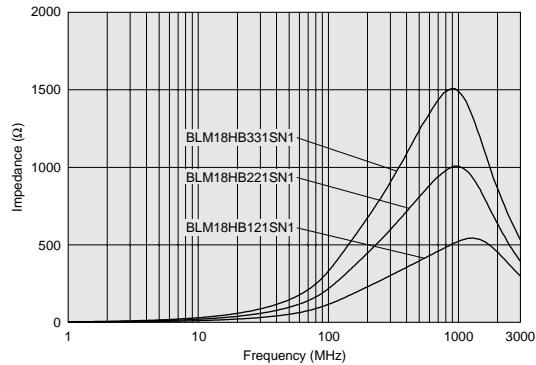

BLM18HK Series (For Digital Interface Lines)

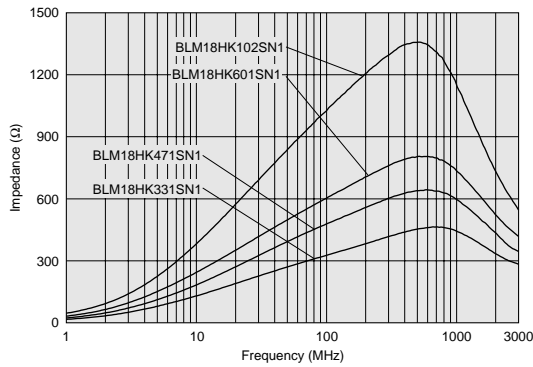

Notice (Rating)

In operating temperature exceeding +85°C, derating of current is necessary for BLM18HE series. Please apply the derating curve shown in chart according to the operating temperature.

Derating

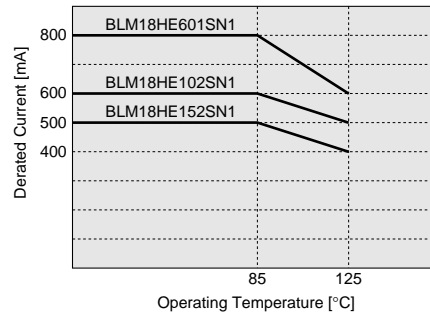

Impedance-Frequency Characteristics

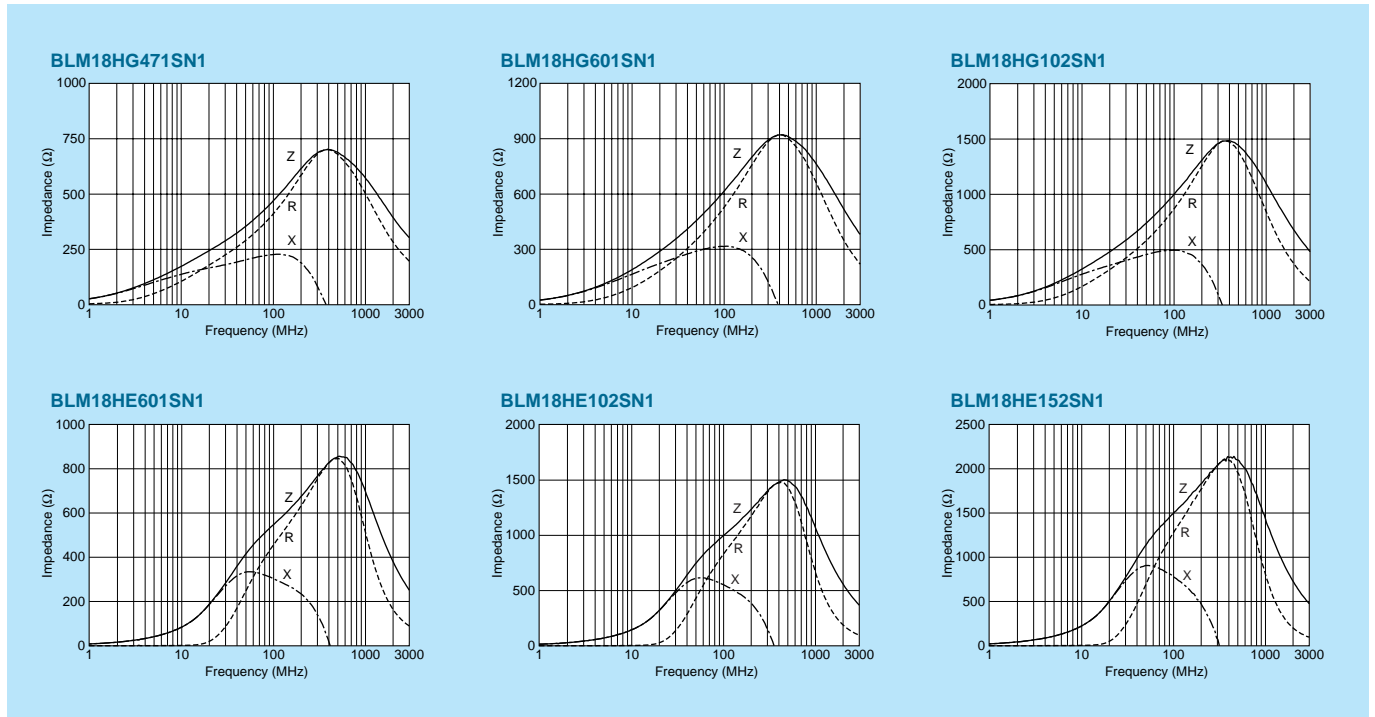

Continued on the following page. ↗

Note • Please read rating and CAUTION (for storage, operating, rating, soldering, mounting and handling) in this catalog to prevent smoking and/or burning, etc.  
 • This catalog has only typical specifications because there is no space for detailed specifications. Therefore, please review our product specifications or consult the approval sheet for product specifications before ordering.

Impedance-Frequency Characteristics

BLM18HD471SN1

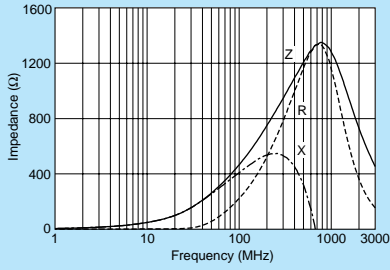

BLM18HD601SN1

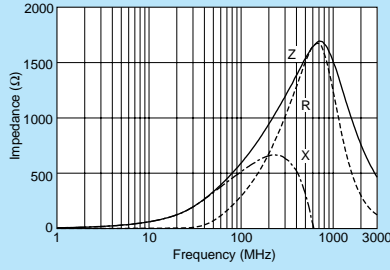

BLM18HD102SN1

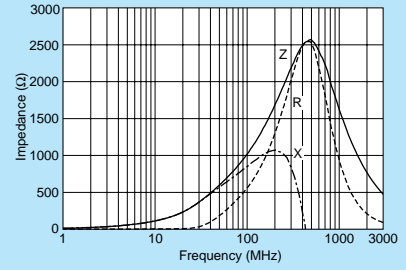

BLM18HB121SN1

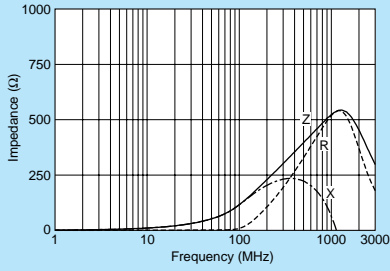

BLM18HB221SN1

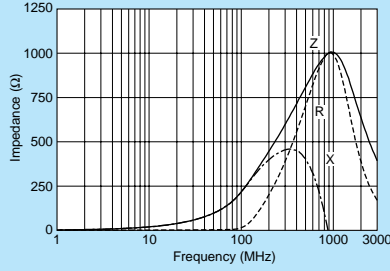

BLM18HB331SN1

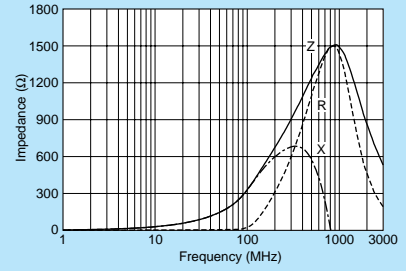

BLM18HK331SN1

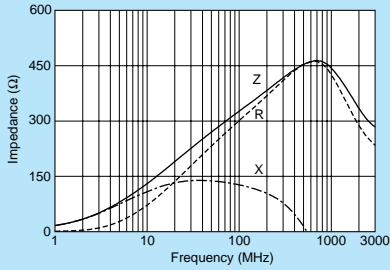

BLM18HK471SN1

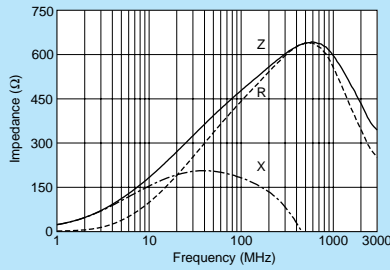

BLM18HK601SN1

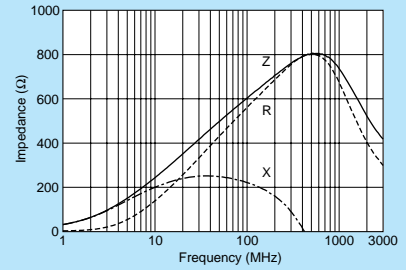

BLM18HK102SN1

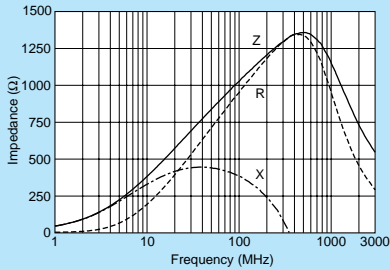

Note • Please read rating and CAUTION (for storage, operating, rating, soldering, mounting and handling) in this catalog to prevent smoking and/or burning, etc.  
 • This catalog has only typical specifications because there is no space for detailed specifications. Therefore, please review our product specifications or consult the approval sheet for product specifications before ordering.

# Noise Suppression of BLM18H in UHF Range

Testing Circuit

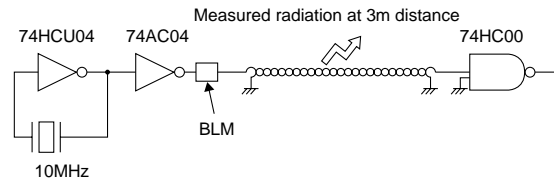

Type of Filter      EMI Suppression Effect / Description

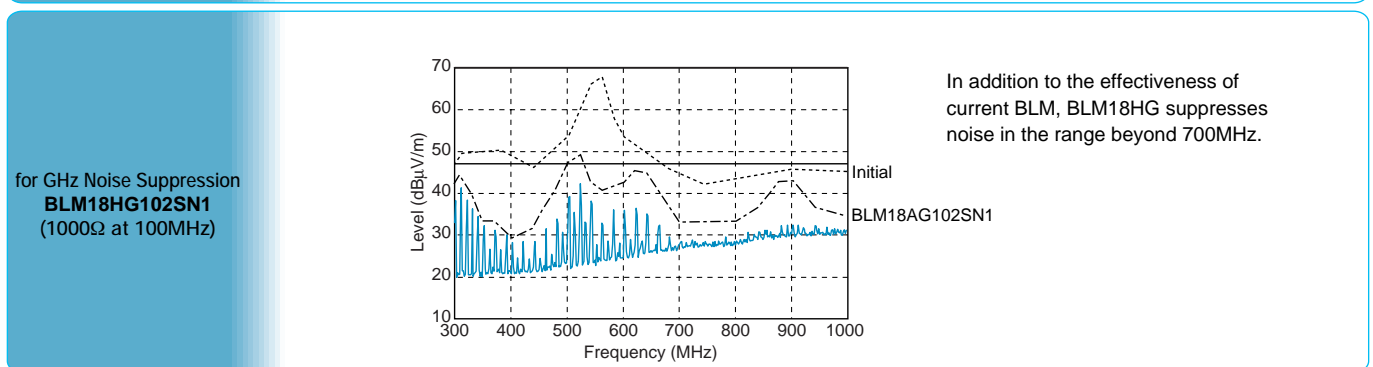
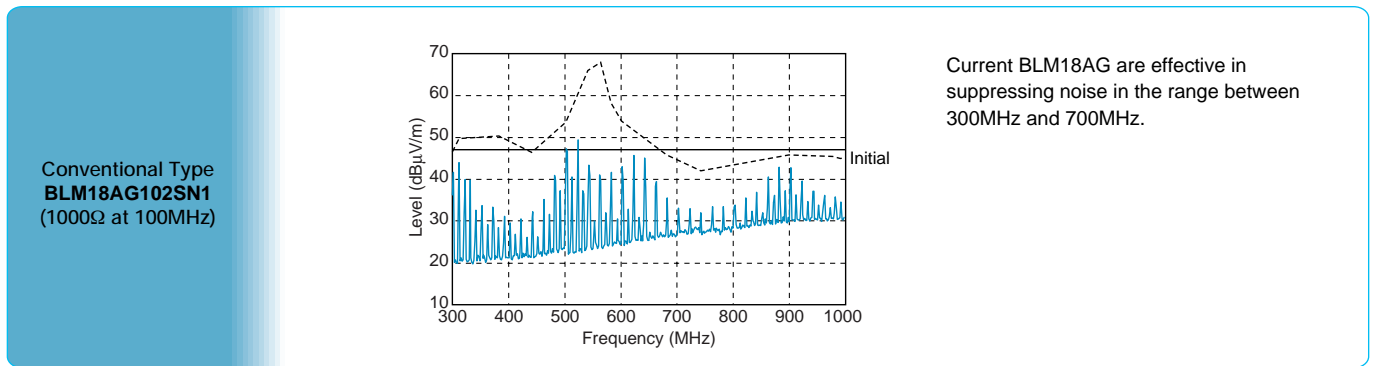
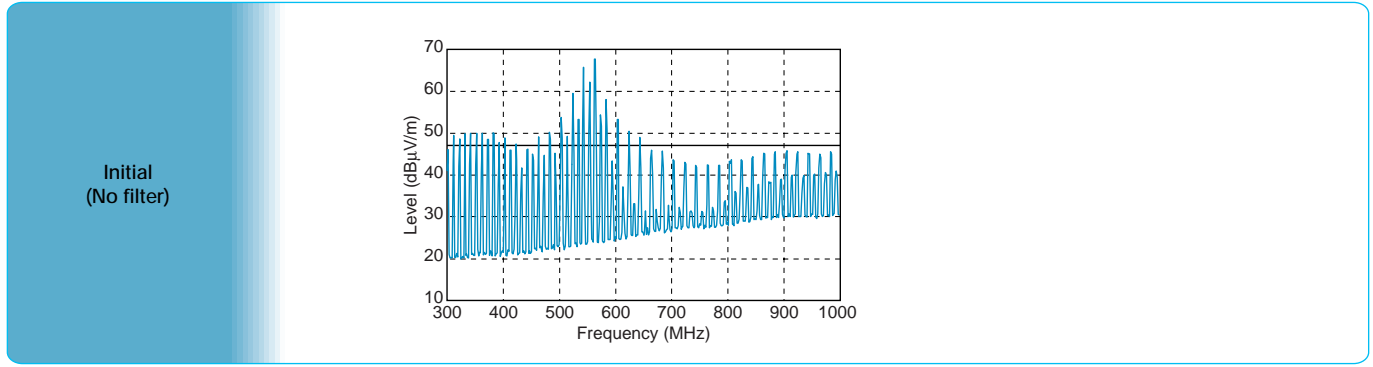

Comparison between BLM18HG102SN1 and BLM18AG102SN1 (Current Item)

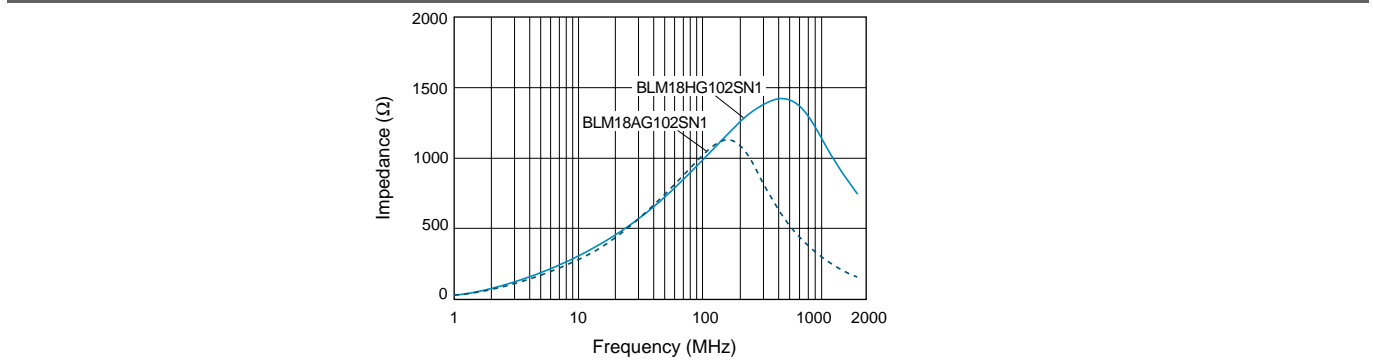

△Note • Please read rating and △CAUTION (for storage, operating, rating, soldering, mounting and handling) in this catalog to prevent smoking and/or burning, etc.  
• This catalog has only typical specifications because there is no space for detailed specifications. Therefore, please review our product specifications or consult the approval sheet for product specifications before ordering.

# BLM15G Series (0402 Size)



Available up to high-GHz band noise.

### ■ Dimensions

(in mm)

### ■ Equivalent Circuit

(Resistance element becomes dominant at high frequencies.)

### ■ Packaging

Code	Packaging	Minimum Quantity
D	180mm Reel Paper Tape	10000
J	330mm Reel Paper Tape	50000
B	Bulk(Bag)	1000

Refer to pages from p.91 to p.94 for mounting information.

### ■ Rated Value (□: packaging code)

Part Number	Impedance (at 100MHz/20°C)	Impedance (at 1GHz/20°C)	Rated Current	DC Resistance	Operating Temperature Range	
BLM15GG221SN1□	220ohm±25%	600ohm±40%	300mA	0.7ohm max.	-55°C to +125°C	Kit
BLM15GG471SN1□	470ohm±25%	1200ohm±40%	200mA	1.3ohm max.	-55°C to +125°C	Kit
BLM15GA750SN1□	75ohm±25%	1000ohm±40%	200mA	1.3ohm max.	-55°C to +125°C	Kit

Number of Circuits: 1

### ■ Impedance-Frequency Characteristics (Main Items)

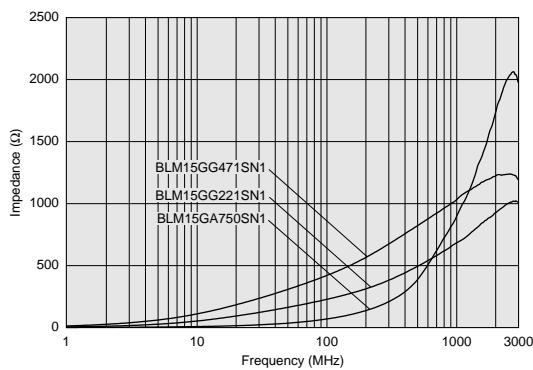

### ■ Impedance-Frequency Characteristics

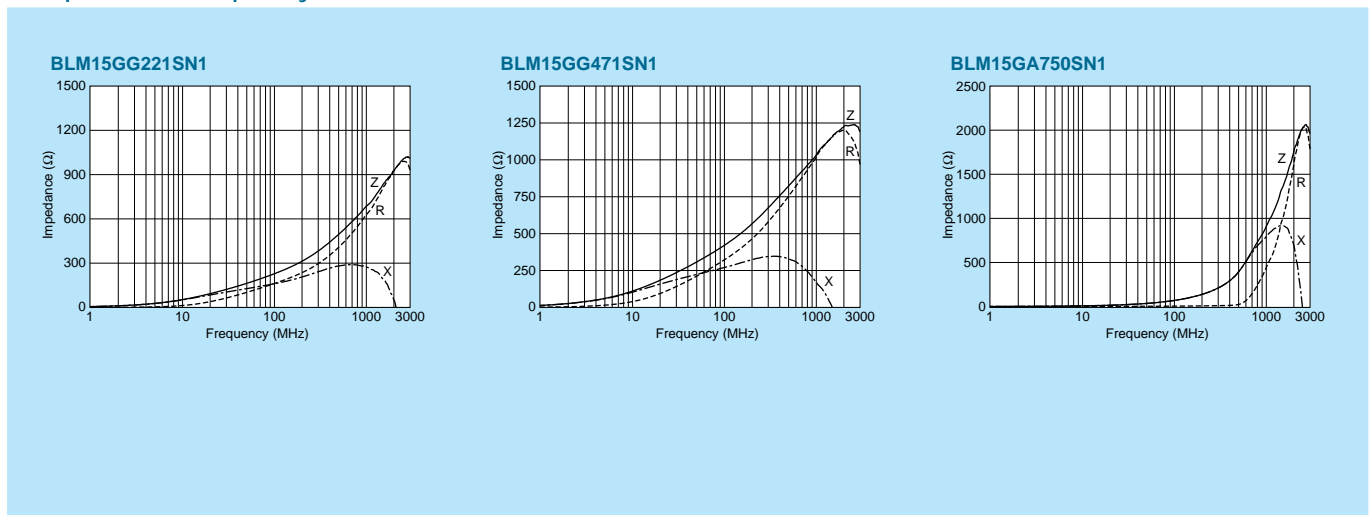

△Note • Please read rating and △CAUTION (for storage, operating, rating, soldering, mounting and handling) in this catalog to prevent smoking and/or burning, etc.  
 • This catalog has only typical specifications because there is no space for detailed specifications. Therefore, please review our product specifications or consult the approval sheet for product specifications before ordering.



# BLM18G Series (0603 Size)



Available up to high-GHz band noise.

Chip Ferrite Bead  
Signal Lines Type

Chip EMIFIL®

Chip Common Mode Choke Coil

Block Type EMIFIL®



### ■ Dimensions

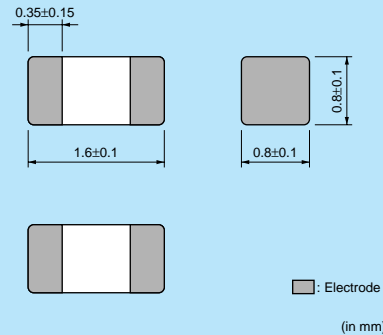

### ■ Equivalent Circuit

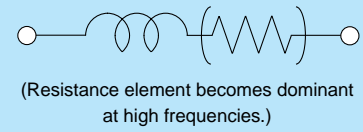

### ■ Packaging

Code	Packaging	Minimum Quantity
D	180mm Reel Paper Tape	4000
J	330mm Reel Paper Tape	10000
B	Bulk(Bag)	1000

Refer to pages from p.91 to p.94 for mounting information.

### ■ Rated Value (□: packaging code)

Part Number	Impedance (at 100MHz/20°C)	Impedance (at 1GHz/20°C)	Rated Current	DC Resistance	Operating Temperature Range	
<b>BLM18GG471SN1</b> □	470ohm±25%	1800ohm±30%	200mA	1.0ohm ±0.3ohm	-55°C to +125°C	<b>Kit</b>

Number of Circuits: 1

### ■ Impedance-Frequency Characteristics (Main Items)

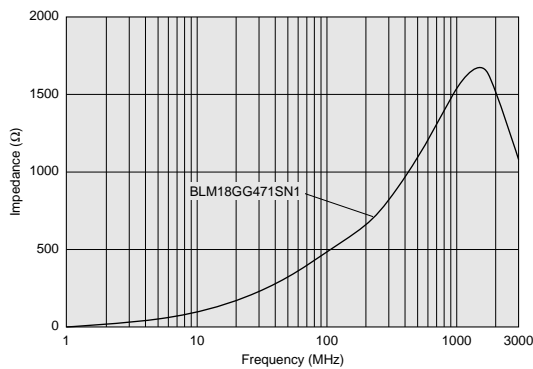

### ■ Impedance-Frequency Characteristics

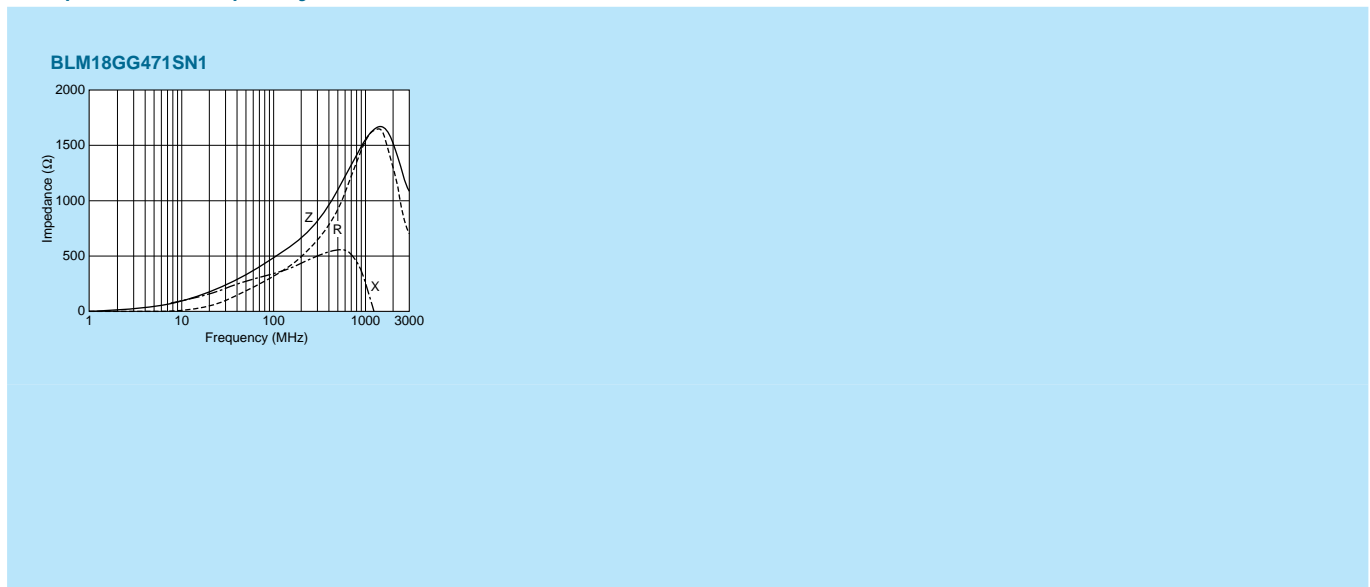

△Note • Please read rating and △CAUTION (for storage, operating, rating, soldering, mounting and handling) in this catalog to prevent smoking and/or burning, etc.  
• This catalog has only typical specifications because there is no space for detailed specifications. Therefore, please review our product specifications or consult the approval sheet for product specifications before ordering.

# BLA2AA/BLA2AB Series (0804 Size)



4-lines array, 0804 size.

### ■ Dimensions

(1) (2) (3) (4)  
(5) (6) (7) (8)

0.2±0.15  
1.0±0.2  
2.0±0.2  
0.5±0.1  
0.25±0.15  
0.5±0.1

■ Electrode  
(in mm)

### ■ Equivalent Circuit

No polarity.

### ■ Packaging

Code	Packaging	Minimum Quantity
D	180mm Reel Paper Tape	10000
J	330mm Reel Paper Tape	50000
B	Bulk(Bag)	1000

Refer to pages from p.91 to p.94 for mounting information.

## ■ Rated Value (□: packaging code)

Part Number	Impedance (at 100MHz/20°C)	Rated Current	DC Resistance	Operating Temperature Range
BLA2AAG121SN4□	120ohm±25%	100mA	0.50ohm max.	-55°C to +125°C
BLA2AAG221SN4□	220ohm±25%	50mA	0.70ohm max.	-55°C to +125°C
BLA2AAG601SN4□	600ohm±25%	50mA	1.10ohm max.	-55°C to +125°C
BLA2AAG102SN4□	1000ohm±25%	50mA	1.30ohm max.	-55°C to +125°C
BLA2ABD750SN4□	75ohm±25%	200mA	0.20ohm max.	-55°C to +125°C
BLA2ABD121SN4□	120ohm±25%	200mA	0.35ohm max.	-55°C to +125°C
BLA2ABD221SN4□	220ohm±25%	100mA	0.40ohm max.	-55°C to +125°C
BLA2ABD471SN4□	470ohm±25%	100mA	0.65ohm max.	-55°C to +125°C
BLA2ABD601SN4□	600ohm±25%	100mA	0.80ohm max.	-55°C to +125°C
BLA2ABD102SN4□	1000ohm±25%	50mA	1.00ohm max.	-55°C to +125°C
BLA2ABB100SN4□	10ohm±25%	200mA	0.1ohm max.	-55°C to +125°C
BLA2ABB220SN4□	22ohm±25%	200mA	0.2ohm max.	-55°C to +125°C
BLA2ABB470SN4□	47ohm±25%	200mA	0.35ohm max.	-55°C to +125°C
BLA2ABB121SN4□	120ohm±25%	50mA	0.60ohm max.	-55°C to +125°C
BLA2ABB221SN4□	220ohm±25%	50mA	0.90ohm max.	-55°C to +125°C

Number of Circuits: 4

## ■ Impedance-Frequency Characteristics (Main Items)

### BLA2AAG Series

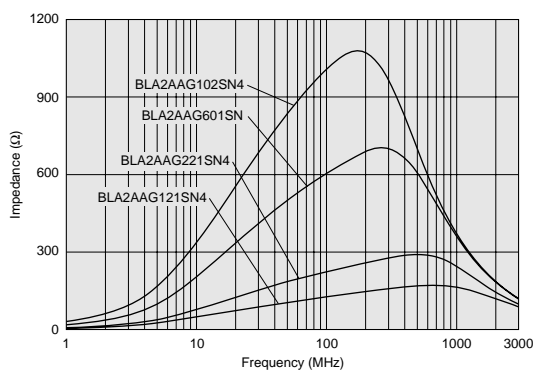

### BLA2ABD Series

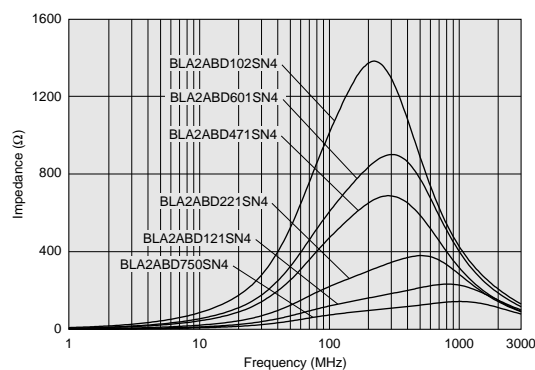

Continued on the following page.

△Note • Please read rating and △CAUTION (for storage, operating, rating, soldering, mounting and handling) in this catalog to prevent smoking and/or burning, etc.  
• This catalog has only typical specifications because there is no space for detailed specifications. Therefore, please review our product specifications or consult the approval sheet for product specifications before ordering.

Impedance-Frequency Characteristics (Main Items)

BLA2ABB Series

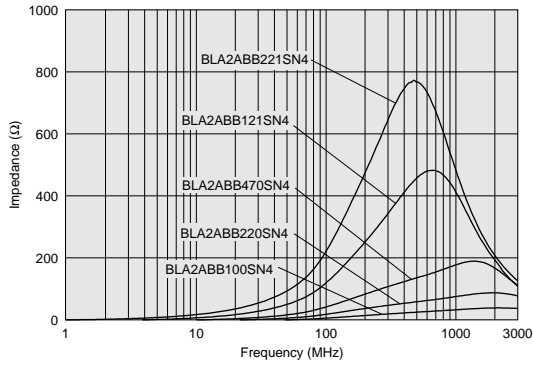

Impedance-Frequency Characteristics

BLA2AAG121SN4

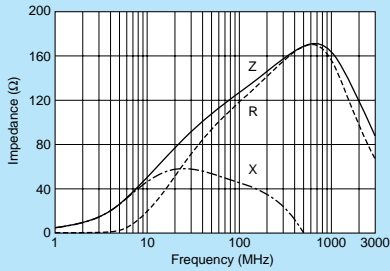

BLA2AAG221SN4

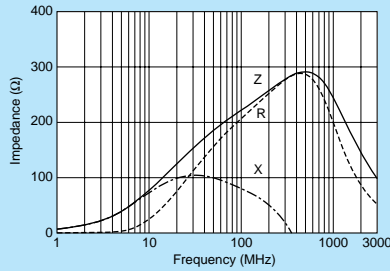

BLA2AAG601SN4

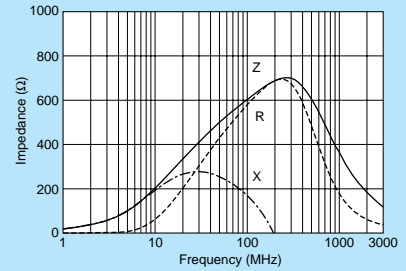

BLA2AAG102SN4

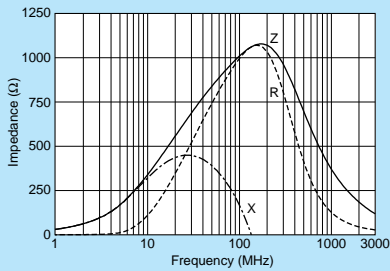

BLA2ABD750SN4

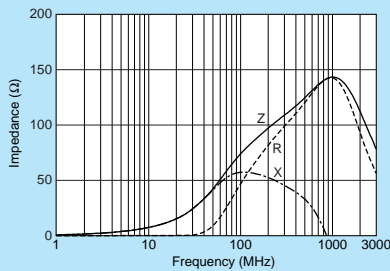

BLA2ABD121SN4

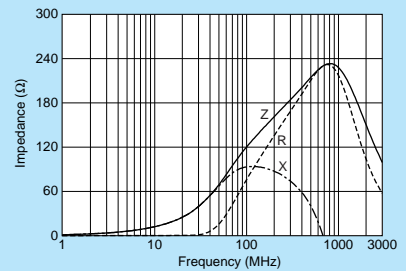

BLA2ABD221SN4

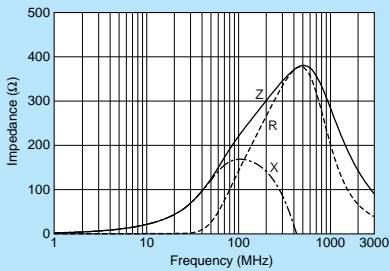

BLA2ABD471SN4

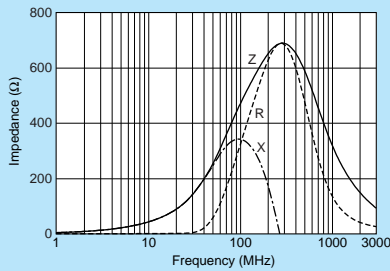

BLA2ABD601SN4

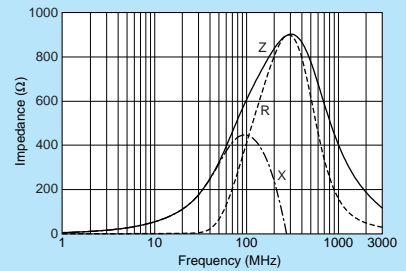

Continued on the following page. ↗

△Note • Please read rating and △CAUTION (for storage, operating, rating, soldering, mounting and handling) in this catalog to prevent smoking and/or burning, etc.  
 • This catalog has only typical specifications because there is no space for detailed specifications. Therefore, please review our product specifications or consult the approval sheet for product specifications before ordering.

Impedance-Frequency Characteristics

BLA2ABD102SN4

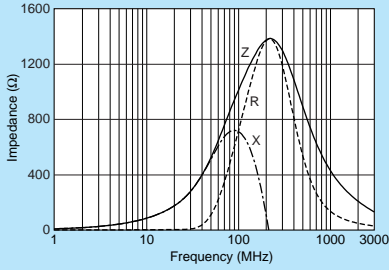

BLA2ABB100SN4

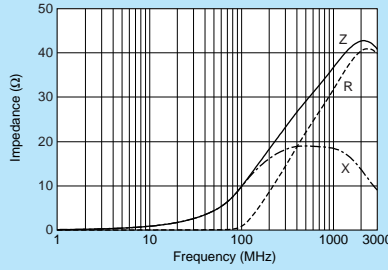

BLA2ABB220SN4

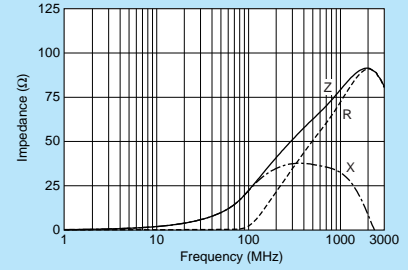

BLA2ABB470SN4

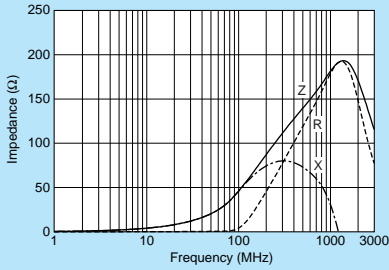

BLA2ABB121SN4

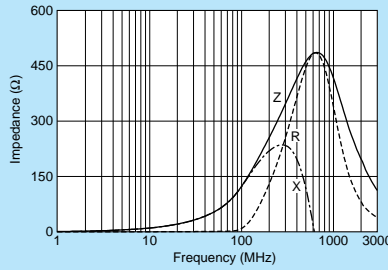

BLA2ABB221SN4

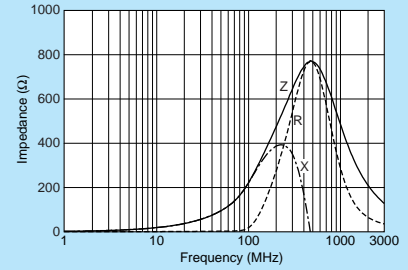

Signal Lines Type  
 Chip Ferrite Bead

Chip EMIFIL®

Chip Common Mode Choke Coil

Block Type EMIFIL®

⚠Note • Please read rating and ⚠CAUTION (for storage, operating, rating, soldering, mounting and handling) in this catalog to prevent smoking and/or burning, etc.  
 • This catalog has only typical specifications because there is no space for detailed specifications. Therefore, please review our product specifications or consult the approval sheet for product specifications before ordering.

# BLA31A/BLA31B Series (1206 Size)



4-lines array, 1206 size.

Chip Ferrite Bead  
Signal Lines Type

Chip EMIFIL®

Chip Common Mode Choke Coil

Block Type EMIFIL®

### ■ Dimensions

Legend:  Electrode (in mm)

### ■ Equivalent Circuit

No polarity.

### ■ Packaging

Code	Packaging	Minimum Quantity
D	180mm Reel Paper Tape	4000
J	330mm Reel Paper Tape	10000
B	Bulk(Bag)	1000

Refer to pages from p.91 to p.94 for mounting information.

## ■ Rated Value (□: packaging code)

Part Number	Impedance (at 100MHz/20°C)	Rated Current	DC Resistance	Operating Temperature Range
BLA31AG300SN4□	30ohm±25%	200mA	0.10ohm max.	-55°C to +125°C
BLA31AG600SN4□	60ohm±25%	200mA	0.15ohm max.	-55°C to +125°C
BLA31AG121SN4□	120ohm±25%	150mA	0.20ohm max.	-55°C to +125°C
BLA31AG221SN4□	220ohm±25%	150mA	0.25ohm max.	-55°C to +125°C
BLA31AG601SN4□	600ohm±25%	100mA	0.35ohm max.	-55°C to +125°C
BLA31AG102SN4□	1000ohm±25%	50mA	0.45ohm max.	-55°C to +125°C
BLA31BD121SN4□	120ohm±25%	150mA	0.30ohm max.	-55°C to +125°C
BLA31BD221SN4□	220ohm±25%	150mA	0.35ohm max.	-55°C to +125°C
BLA31BD471SN4□	470ohm±25%	100mA	0.40ohm max.	-55°C to +125°C
BLA31BD601SN4□	600ohm±25%	100mA	0.45ohm max.	-55°C to +125°C
BLA31BD102SN4□	1000ohm±25%	50mA	0.55ohm max.	-55°C to +125°C

Number of Circuits: 4

## ■ Impedance-Frequency Characteristics (Main Items)

### BLA31AG Series

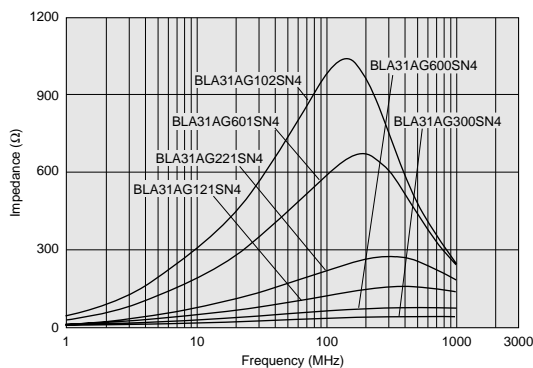

### BLA31BD Series

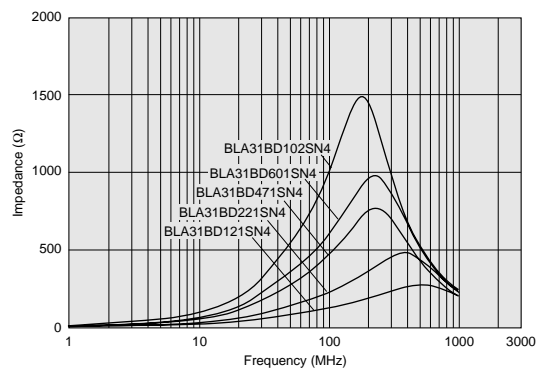

Continued on the following page.

△Note • Please read rating and △CAUTION (for storage, operating, rating, soldering, mounting and handling) in this catalog to prevent smoking and/or burning, etc.  
• This catalog has only typical specifications because there is no space for detailed specifications. Therefore, please review our product specifications or consult the approval sheet for product specifications before ordering.

Impedance-Frequency Characteristics

BLA31AG300SN4

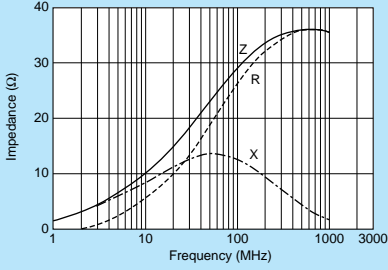

BLA31AG600SN4

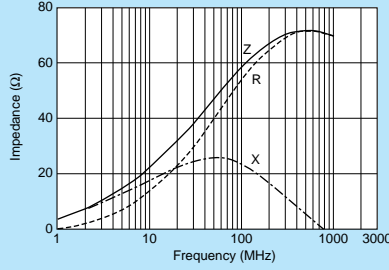

BLA31AG121SN4

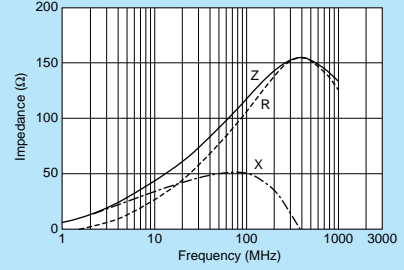

BLA31AG221SN4

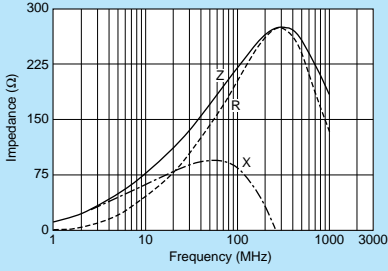

BLA31AG601SN4

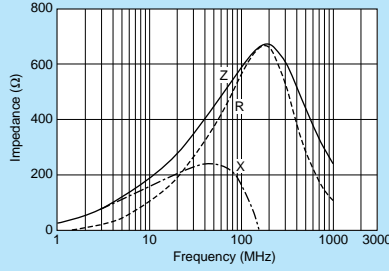

BLA31AG102SN4

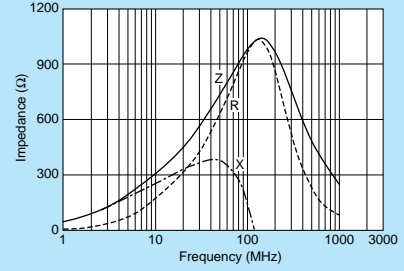

BLA31BD121SN4

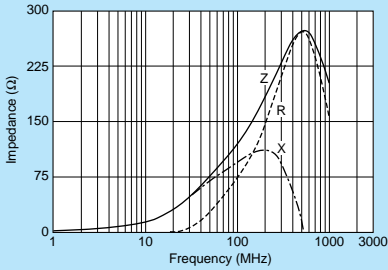

BLA31BD221SN4

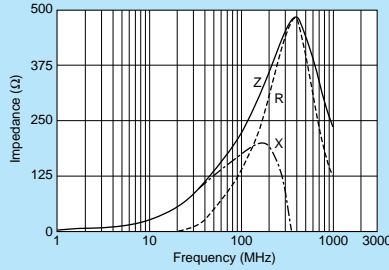

BLA31BD471SN4

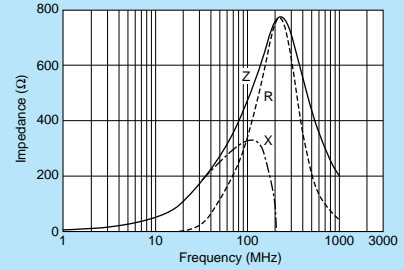

BLA31BD601SN4

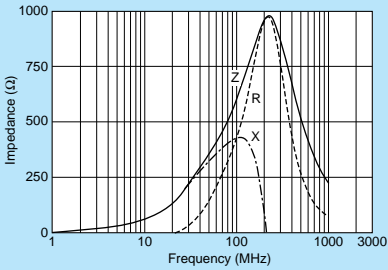

BLA31BD102SN4

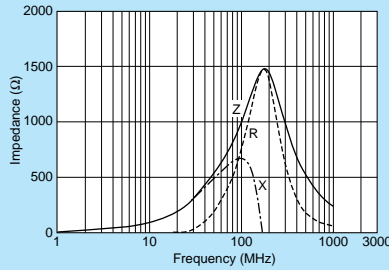

Note • Please read rating and CAUTION (for storage, operating, rating, soldering, mounting and handling) in this catalog to prevent smoking and/or burning, etc.  
 • This catalog has only typical specifications because there is no space for detailed specifications. Therefore, please review our product specifications or consult the approval sheet for product specifications before ordering.

## ⚠ Caution

## ● Rating

1. About the Rated Current  
Do not use products beyond the rated current as this may create excessive heat and deteriorate the insulation resistance.
2. About the Excessive Surge Current  
Excessive surge current ( pulse current or rush current) than specified rated current applied to the product may cause a critical failure, such as an open circuit, burnout caused by excessive temperature rise. Please contact us in advance in case of applying the surge current.

## ● Soldering and Mounting

- Self-heating  
Please provide special attention when mounting chip ferrite beads BLM\_AX/P/K/S series in close proximity to other products that radiate heat.  
The heat generated by other products may deteriorate the insulation resistance and cause excessive heat in this component.

## Notice

## ● Storage and Operating Conditions

## &lt;Operating Environment&gt;

Do not use products in a chemical atmosphere such as chlorine gas, acid or sulfide gas.

Do not use products in the environment close to the organic solvent.

## &lt;Storage and Handling Requirements&gt;

1. Storage Period  
BLM15E/15H/15G series should be used within 12 months, the other series should be used within 6 months.  
Solderability should be checked if this period is exceeded.
2. Storage Conditions
  - (1) Storage temperature: -10 to +40°C  
Relative humidity: 15 to 85%  
Avoid sudden changes in temperature and humidity.
  - (2) Do not store products in a chemical atmosphere such as chlorine gas, acid or sulfide gas.

## ● Notice (Soldering and Mounting)

1. Cleaning  
Failure and degradation of a product are caused by the cleaning method. When you clean in conditions that are not in mounting information, please contact Murata engineering.
2. Soldering  
Reliability decreases with improper soldering methods. Please solder by the standard soldering conditions shown in mounting information.
3. Other  
Noise suppression levels resulting from Murata's EMI suppression filters EMIFIL® may vary, depending on the circuits and ICs used, type of noise, mounting pattern, mounting location, and other operating conditions. Be sure to check and confirm in advance the noise suppression effect of each filter, in actual circuits, etc. before applying the filter in a commercial-purpose equipment design.

## ● Handling

1. Resin Coating  
Using resin for coating/molding products may affect the products performance.  
So please pay careful attention in selecting resin.  
Prior to use, please make the reliability evaluation with the product mounted in your application set.
2. Handling of a Substrate  
After mounting products on a substrate, do not apply any stress to the product caused by bending or twisting to the substrate when cropping the substrate, inserting and removing a connector from the substrate or tightening screw to the substrate.  
Excessive mechanical stress may cause cracking in the Product.

Bending

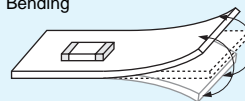

Twisting

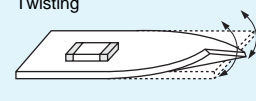

### 1. Standard Land Pattern Dimensions

Land Pattern  
 Land Pattern + Solder Resist  
 Solder Resist

(in mm)

**BLM02**  
**BLM03**  
**BLM15**  
 (Except BLM 15\_AN1 series)  
**BLM18**  
**BLM21**  
**BLM31**  
**BLM41**

●Reflow and Flow  
BLM Series

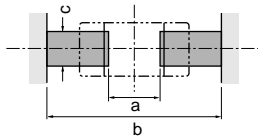

BLM□□AX/P/K/S

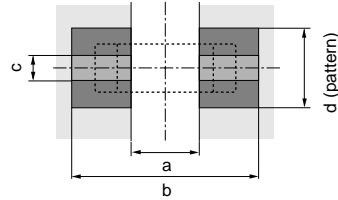

Type	Soldering	a	b	c
<b>BLM02</b>	Reflow	0.16-0.2	0.4-0.56	0.2-0.23
<b>BLM03</b>	Reflow	0.2-0.3	0.6-0.9	0.3
<b>BLM15</b>	Reflow	0.4	1.2-1.4	0.5
<b>BLM18</b>	Flow (except 18G)	0.7	2.2-2.6	0.7
	Reflow		1.8-2.0	
<b>BLM21</b>	Flow/ Reflow	1.2	3.0-4.0	1.0

• Except BLM03PG/15AX-PD-PG/18PG-KG-SG/21PG. And BLM02/03/15/18G is specially adapted for reflow soldering.

Type	Rated Current (A)	Soldering	a	b	c	Land Pad Thickness and Dimension d		
						18μm	35μm	70μm
<b>BLM03AX</b>	1max.	Reflow	0.2-0.3	0.6-0.9	0.3	0.3	0.3	0.3
<b>BLM03PG</b>								
<b>BLM15AX</b>	1.5max.	Reflow	0.4	1.2-1.4	0.5	0.5	0.5	0.5
<b>BLM15P□</b>	2.2max.					1.2	0.7	0.5
<b>BLM18PG</b>	0.5-1.5	Flow/ Reflow	0.7	2.2-2.6 Reflow 1.8-2.0	0.7	0.7	0.7	0.7
	1.7-2.5					1.2	0.7	0.7
<b>BLM18KG</b>	3-4					2.4	1.2	0.7
<b>BLM18SG</b>	6					6.4	3.3	1.65
<b>BLM21PG</b>	1.5	Flow/ Reflow	1.2	3.0-4.0	1.0	1.0	1.0	1.0
	2					1.2	1.0	1.0
	3					2.4	1.2	1.0
	6					6.4	3.3	1.65
<b>BLM31PG</b>	1.5/2	Flow/ Reflow	2.0	4.2-5.2	1.2	1.2	1.2	1.2
	3					2.4	1.2	1.2
	6					6.4	3.3	1.65
<b>BLM41PG</b>	1.5/2	Flow/ Reflow	3.0	5.5-6.5	1.2	1.2	1.2	1.2
	3					2.4	1.2	1.2
	6					6.4	3.3	1.65

• Do not apply narrower pattern than listed above to BLM□□AX/P/K/S. Narrow pattern can cause excessive heat or open circuit.

**BLA2A**  
**BLA31**

●Reflow Soldering

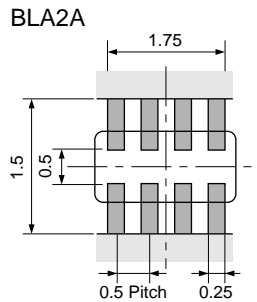

●Reflow and Flow

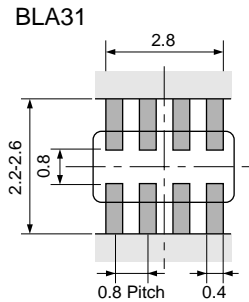

• If there are high amounts of self-heating on pattern, the contact points of PCB and part may become damaged.

△Note • Please read rating and △CAUTION (for storage, operating, rating, soldering, mounting and handling) in this catalog to prevent smoking and/or burning, etc.  
 • This catalog has only typical specifications because there is no space for detailed specifications. Therefore, please review our product specifications or consult the approval sheet for product specifications before ordering.



● PCB Warping

PCB should be designed so that products are not subjected to the mechanical stress caused by warping the board.

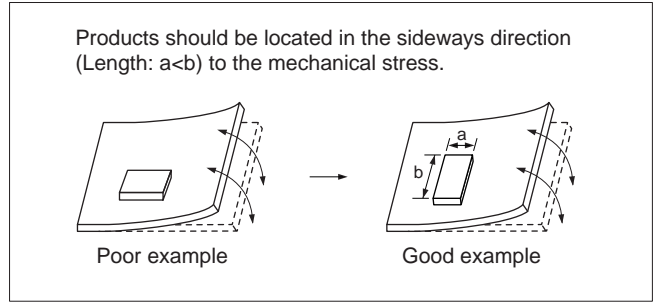

**2. Solder Paste Printing and Adhesive Application**

When reflow soldering the chip ferrite beads, the printing must be conducted in accordance with the following cream solder printing conditions.

If too much solder is applied, the chip will be prone to damage by mechanical and thermal stress from the PCB and may crack.

Standard land dimensions should be used for resist and copper foil patterns.

When flow soldering the chip ferrite beads, apply the adhesive in accordance with the following conditions. If too much adhesive is applied, then it may overflow into the land or termination areas and yield poor solderability. In contrast, if insufficient adhesive is applied, or if the adhesive is not sufficiently hardened, then the chip may become detached during flow soldering process.

(in mm)

Series	Solder Paste Printing	Adhesive Application
<p><b>BLM</b> (Except BLM 15_AN1 series)</p>	<ul style="list-style-type: none"> <li>● Ensure that solder is applied smoothly to a minimum height of 0.2mm to 0.3mm at the end surface of the part.</li> <li>● Guideline of solder paste thickness: 50-80μm: BLM02 100-150μm: BLM03 100-200μm: BLM15/18/21/31/41</li> </ul>	<ul style="list-style-type: none"> <li>■ <b>BLM18/21/31/41 Series</b> (Except BLM18G Series) Coating amount is illustrated in the following diagram.</li> </ul>
<p><b>BLA</b></p>	<ul style="list-style-type: none"> <li>● Guideline of solder paste thickness: 100-150μm: BLA2A 150-200μm: BLA31</li> </ul>	<ul style="list-style-type: none"> <li>■ <b>BLA31 Series</b> Coating amount is illustrated in the following diagram.</li> </ul>

△Note • Please read rating and △CAUTION (for storage, operating, rating, soldering, mounting and handling) in this catalog to prevent smoking and/or burning, etc.  
• This catalog has only typical specifications because there is no space for detailed specifications. Therefore, please review our product specifications or consult the approval sheet for product specifications before ordering.

### 3. Standard Soldering Conditions

#### (1) Soldering Methods

Use flow and reflow soldering methods only.  
 Use standard soldering conditions when soldering chip ferrite beads.  
 In cases where several different parts are soldered, each having different soldering conditions, use those conditions requiring the least heat and minimum time.

Solder: Use Sn-3.0Ag-0.5Cu solder. Use of Sn-Zn based solder will deteriorate performance of products.  
 If using BLA series with Sn-Zn based solder, please contact Murata in advance.

#### Flux:

- Use Rosin-based flux.  
 In case of using RA type solder, products should be cleaned completely with no residual flux.
- Do not use strong acidic flux (with chlorine content exceeding 0.20wt%)
- Do not use water-soluble flux.

For additional mounting methods, please contact Murata.

#### (2) Soldering Profile

- Flow Soldering profile  
 ( Sn-3.0Ag-0.5Cu Solder)

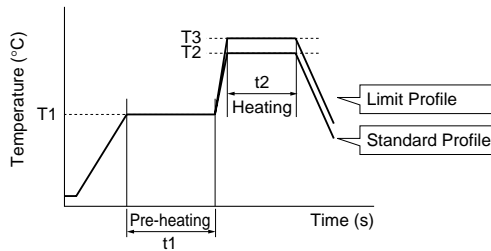

Series	Pre-heating		Standard Profile			Limit Profile		
	Temp. (T1)	Time. (t1)	Heating		Cycle of Flow	Heating		Cycle of Flow
			Temp. (T2)	Time. (t2)		Temp. (T3)	Time. (t2)	
<b>BLM (Except BLM02/03/15/18G) BLA31</b>	150°C	60s min.	250°C	4 to 6s	2 times max.	265±3°C	5s max.	2 times max.

- Reflow Soldering Profile  
 (Sn-3.0Ag-0.5Cu Solder)

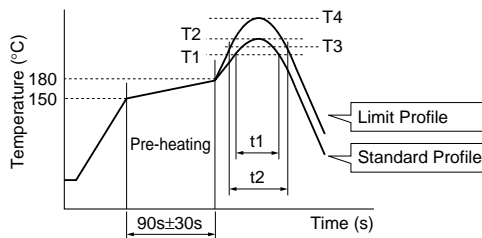

Series	Standard Profile				Limit Profile			
	Heating		Peak Temperature (T2)	Cycle of Reflow	Heating		Peak Temperature (T4)	Cycle of Reflow
	Temp. (T1)	Time. (t1)			Temp. (T3)	Time. (t2)		
<b>BLM BLA</b>	220°C min.	30 to 60s	245±3°C	2 times max.	230°C min.	60s max.	260°C/10s	2 times max.

△Note • Please read rating and △CAUTION (for storage, operating, rating, soldering, mounting and handling) in this catalog to prevent smoking and/or burning, etc.  
 • This catalog has only typical specifications because there is no space for detailed specifications. Therefore, please review our product specifications or consult the approval sheet for product specifications before ordering.

(3) Reworking with Solder Iron

The following conditions must be strictly followed when using a soldering iron. (Except BLM02 Series)  
 Pre-heating: 150°C 60s min.  
 Soldering iron power output / Tip diameter:  
 80W max. / ø3mm max.

Temperature of soldering iron tip / Soldering time / Times:  
 350°C max. / 3-4s / 2 times  
 Do not allow the tip of the soldering iron to directly contact the chip.  
 For additional methods of reworking with a soldering iron, please contact Murata engineering.

**4. Cleaning**

Following conditions should be observed when cleaning chip ferrite beads.

- (1) Cleaning Temperature: 60°C max. (40°C max. for alcohol type cleaner)
- (2) Ultrasonic  
 Output: 20W/liter max.  
 Duration: 5 minutes max.  
 Frequency: 28 to 40kHz
- (3) Cleaning Agent

The following list of cleaning agents have been tested on the individual components. Evaluation of final assembly should be completed prior to production.

- (a) Alcohol cleaning agent  
 Isopropyl alcohol (IPA)
- (b) Aqueous cleaning agent  
 Pine Alpha ST-100S
- (4) Ensure that flux residue is completely removed. Component should be thoroughly dried after aqueous agent has been removed with deionized water.
- (5) BLM\_G type is processed with resin. On rinsing the product, using water for ultrasonic cleaning may affect the resin quality used for the product by water element. In case of set cleaning conditions, please make sure the reliability according to the cleaning conditions.

**5. Mounting of BLM15\_AN1 Series**

BLM15\_AN1 is series for wire bonding mounting.

(1) Die Bonding Mounting

(a) Dimension of Standard Metal Mask

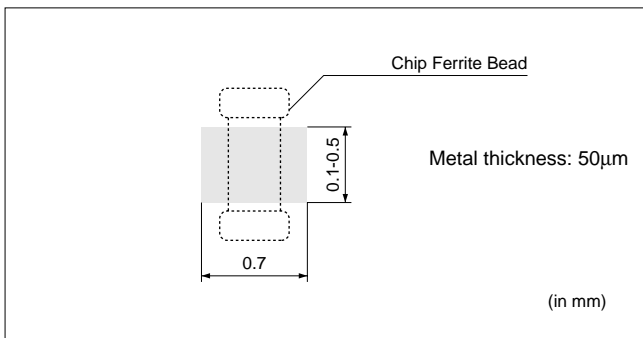

- (b) Die Bonding Agent
  - Use adhesive for die bonding for which the curing temperature is 200°C or less.
- (c) Notice
  - Use a flat surface of substrate for bonding mounting. Slant mounting of product may affect the wire bonding.
  - Adhesive for die bonding may affect the mounting reliability in wire bonding. Make sure of the mounting reliability with the adhesive to be used in advance.

△Note • Please read rating and △CAUTION (for storage, operating, rating, soldering, mounting and handling) in this catalog to prevent smoking and/or burning, etc.  
 • This catalog has only typical specifications because there is no space for detailed specifications. Therefore, please review our product specifications or consult the approval sheet for product specifications before ordering.

## Minimum Quantity and Dimensions of 8mm Width Paper / Embossed Tape

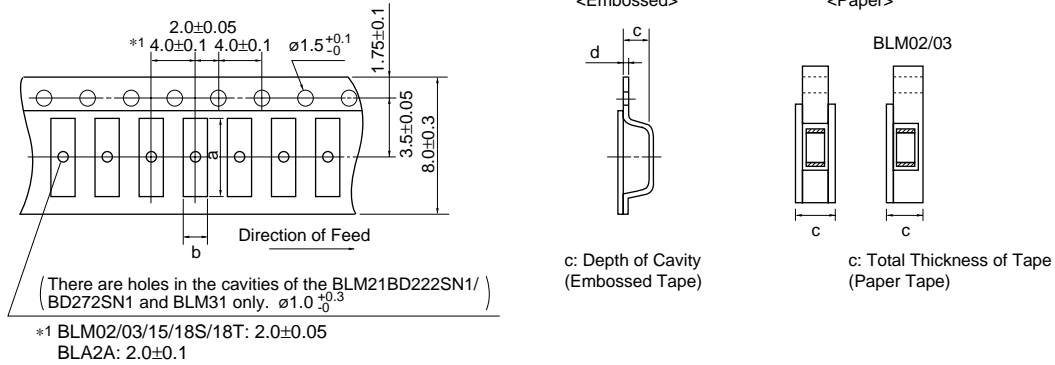

Part Number	Cavity Size (mm)				Minimum Qty. (pcs.)				
					ø180mm Reel		ø330mm Reel		Bulk
	a	b	c	d	Paper Tape	Embossed Tape	Paper Tape	Embossed Tape	
BLM02	0.45	0.25	0.40 max.	-	20000	-	-	-	1000
BLM03	0.70	0.40	0.55 max.	-	15000	-	50000	-	1000
BLM15	1.15	0.65	0.8 max.	-	10000	-	50000	-	1000
BLM18	1.85	1.05	1.1 max.	-	4000	-	10000	-	1000
BLM18EG/KG_TN	1.85	1.05	0.85 max.	-	4000	-	10000	-	1000
BLM18EG/KG_SN			1.1 max.						
BLM18S	1.85	1.05	0.90 max.	-	10000	-	30000	-	1000
BLM18T	1.85	1.05	0.90 max.	-	10000	-	-	-	1000
BLM21	2.25	1.45	1.1 max.	-	4000	-	10000	-	1000
BLM31	3.5	1.9	1.3	0.2	-	3000	-	10000	1000
BLM21BD222SN1/272SN1	2.25	1.45	1.3	0.2	-	3000	-	10000	1000
BLA2A	2.2	1.2	0.8 max.	-	10000	-	50000	-	1000
BLA31	3.4	1.8	1.1 max.	-	4000	-	10000	-	1000

(in mm)

## Minimum Quantity and Dimensions of 12mm Width Embossed Tape

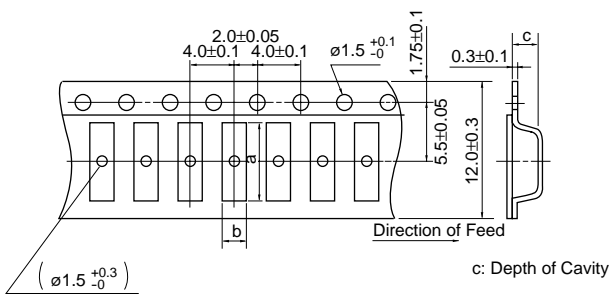

Part Number	Cavity Size			Minimum Qty. (pcs.)		
	a	b	c	ø180mm Reel	ø330mm Reel	Bulk
BLM41	4.8	1.9	1.75	2500	8000	1000

(in mm)

"Minimum Quantity" means the number of units of each delivery or order. The quantity should be an integral multiple of the "Minimum Quantity".

⚠Note • Please read rating and ⚠CAUTION (for storage, operating, rating, soldering, mounting and handling) in this catalog to prevent smoking and/or burning, etc.  
• This catalog has only typical specifications because there is no space for detailed specifications. Therefore, please review our product specifications or consult the approval sheet for product specifications before ordering.

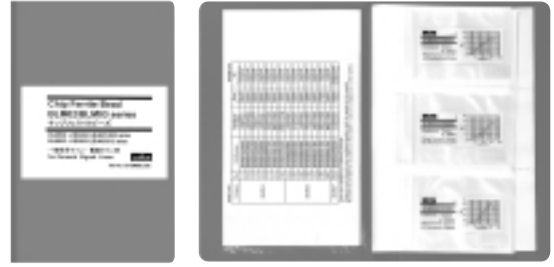

●EKEMBL03G (Chip Ferrite Beads 01005 Size / 0201 Size)

No.	Part Number	Quantity (pcs.)	Impedance typ. (at 100MHz, 20 degrees C)	Rated Current (mA)	DC Resistance (Ω) max.
1	BLM02AG100SN1	10	10Ω (Typ.)	500	0.1
2	BLM02AG700SN1	10	70Ω±25%	250	0.5
3	BLM02AG121SN1	10	120Ω±25%	200	0.8
4	BLM03AG100SN1	10	10Ω (Typ.)	500	0.1
5	BLM03AG700SN1	10	70Ω (Typ.)	200	0.4
6	BLM03AG800SN1	10	80Ω±25%	200	0.4
7	BLM03AG121SN1	10	120Ω±25%	200	0.5
8	BLM03AG241SN1	10	240Ω±25%	200	0.8
9	BLM03AG601SN1	10	600Ω±25%	100	1.5
10	BLM03AG102SN1	10	1000Ω±25%	100	2.5
11	BLM03AX100SN1	10	10Ω (Typ.)	1000	0.05
12	BLM03AX800SN1	10	80Ω±25%	500	0.18
13	BLM03AX121SN1	10	120Ω±25%	450	0.23
14	BLM03AX241SN1	10	240Ω±25%	350	0.38
15	BLM03AX601SN1	10	600Ω±25%	250	0.85
16	BLM03AX102SN1	10	1000Ω±25%	200	1.25
17	BLM03BB100SN1	10	10Ω±25%	300	0.4
18	BLM03BB220SN1	10	22Ω±25%	200	0.5
19	BLM03BB470SN1	10	47Ω±25%	200	0.7
20	BLM03BB750SN1	10	75Ω±25%	200	1.0
21	BLM03BB121SN1	10	120Ω±25%	100	1.5
22	BLM03BD750SN1	10	75Ω±25%	300	0.4
23	BLM03BD121SN1	10	120Ω±25%	250	0.5
24	BLM03BD241SN1	10	240Ω±25%	200	0.8
25	BLM03BD471SN1	10	470Ω±25%	215	1.5
26	BLM03BD601SN1	10	600Ω±25%	200	1.7
27	BLM03BC330SN1	10	33Ω±25%	150	0.85
28	BLM03BC560SN1	10	56Ω±25%	100	1.05
29	BLM03BC800SN1	10	80Ω±25%	100	1.40
30	BLM03HG601SN1	10	600Ω±25%	150	1.6
31	BLM03HG102SN1	10	1000Ω±25%	125	2.6
32	BLM03HD331SN1	10	330Ω±25%	200	1.0
33	BLM03HD471SN1	10	470Ω±25%	175	1.3
34	BLM03HD601SN1	10	600Ω±25%	150	1.7
35	BLM03HD102SN1	10	1000Ω±25%	120	2.9
36	BLM03PG220SN1	10	22Ω±25%	900	0.065
37	BLM03PG330SN1	10	33Ω±25%	750	0.090

●EKEMBL15N (Chip Ferrite Beads 0402 Size)

No.	Part Number	Quantity (pcs.)	Impedance typ. (at 100MHz, 20 degrees C)	Rated Current (mA)	DC Resistance (Ω) max.
1	BLM15AG100SN1	10	10Ω (Typ.)	1000	0.05
2	BLM15AG700SN1	10	70Ω (Typ.)	500	0.15
3	BLM15AG121SN1	10	120Ω±25%	500	0.25
4	BLM15AG221SN1	10	220Ω±25%	300	0.35
5	BLM15AG601SN1	10	600Ω±25%	300	0.60
6	BLM15AG102SN1	10	1000Ω±25%	200	1.00
7	BLM15AX100SN1	10	10Ω (Typ.)	1740	0.015
8	BLM15AX300SN1	10	30Ω±25%	1100	0.06
9	BLM15AX700SN1	10	70Ω±25%	780	0.10
10	BLM15AX121SN1	10	120Ω±25%	680	0.13
11	BLM15AX221SN1	10	220Ω±25%	580	0.18
12	BLM15AX601SN1	10	600Ω±25%	420	0.34
13	BLM15AX102SN1	10	1000Ω±25%	350	0.49
14	BLM15BA050SN1	10	5Ω±25%	300	0.10

Continued on the following page.

△Note • Please read rating and △CAUTION (for storage, operating, rating, soldering, mounting and handling) in this catalog to prevent smoking and/or burning, etc.

• This catalog has only typical specifications because there is no space for detailed specifications. Therefore, please review our product specifications or consult the approval sheet for product specifications before ordering.

Continued from the preceding page.

No.	Part Number	Quantity (pcs.)	Impedance typ. (at 100MHz, 20 degrees C)	Rated Current (mA)	DC Resistance ( $\Omega$ ) max.
15	BLM15BA100SN1	10	10 $\Omega$ ±25%	300	0.20
16	BLM15BA220SN1	10	22 $\Omega$ ±25%	300	0.30
17	BLM15BA330SN1	10	33 $\Omega$ ±25%	300	0.40
18	BLM15BA470SN1	10	47 $\Omega$ ±25%	200	0.60
19	BLM15BA750SN1	10	75 $\Omega$ ±25%	200	0.80
20	BLM15BB050SN1	10	5 $\Omega$ ±25%	500	0.08
21	BLM15BB100SN1	10	10 $\Omega$ ±25%	300	0.10
22	BLM15BB220SN1	10	22 $\Omega$ ±25%	300	0.20
23	BLM15BB470SN1	10	47 $\Omega$ ±25%	300	0.35
24	BLM15BB750SN1	10	75 $\Omega$ ±25%	300	0.40
25	BLM15BB121SN1	10	120 $\Omega$ ±25%	300	0.55
26	BLM15BB221SN1	10	220 $\Omega$ ±25%	200	0.80
27	BLM15BC121SN1	10	120 $\Omega$ ±25%	350	0.45
28	BLM15BC241SN1	10	240 $\Omega$ ±25%	250	0.70
29	BLM15BD750SN1	10	75 $\Omega$ ±25%	300	0.20
30	BLM15BD121SN1	10	120 $\Omega$ ±25%	300	0.30
31	BLM15BD221SN1	10	220 $\Omega$ ±25%	300	0.40
32	BLM15BD471SN1	10	470 $\Omega$ ±25%	200	0.60
33	BLM15BD601SN1	10	600 $\Omega$ ±25%	200	0.65
34	BLM15BD102SN1	10	1000 $\Omega$ ±25%	200	0.90
35	BLM15BD182SN1	10	1800 $\Omega$ ±25%	100	1.40
36	BLM15HD601SN1	10	600 $\Omega$ ±25%	300	0.85
37	BLM15HD102SN1	10	1000 $\Omega$ ±25%	250	1.25
38	BLM15HD182SN1	10	1800 $\Omega$ ±25%	200	2.20
39	BLM15HG601SN1	10	600 $\Omega$ ±25%	300	0.70
40	BLM15HG102SN1	10	1000 $\Omega$ ±25%	250	1.10
41	BLM15HB121SN1	10	120 $\Omega$ ±25%	300	0.70
42	BLM15HB221SN1	10	220 $\Omega$ ±25%	250	1.00
43	BLM15EG121SN1	10	120 $\Omega$ ±25%	1500	0.095
44	BLM15EG221SN1	10	220 $\Omega$ ±25%	700	0.28
45	BLM15GG221SN1	10	220 $\Omega$ ±25%	300	0.70
46	BLM15GG471SN1	10	470 $\Omega$ ±25%	200	1.30
47	BLM15GA750SN1	10	75 $\Omega$ ±25%	200	1.30
48	BLM15PG100SN1	10	10 $\Omega$ (Typ.)	1000	0.05
49	BLM15PD300SN1	10	30 $\Omega$ ±25%	2200	0.035
50	BLM15PD600SN1	10	60 $\Omega$ ±25%	1700	0.06
51	BLM15PD800SN1	10	80 $\Omega$ ±25%	1500	0.07
52	BLM15PD121SN1	10	120 $\Omega$ ±25%	1300	0.09
53	BLM15PX121SN1	10	120 $\Omega$ ±25%	1800	0.06

## ●EKEMBL18H (Chip Ferrite Beads 0603 Size)

No.	Part Number	Quantity (pcs.)	Impedance typ. (at 100MHz, 20 degrees C)	Rated Current (mA)	DC Resistance ( $\Omega$ ) max.
1	BLM18AG121SN1	10	120 $\Omega$ ±25%	500	0.18
2	BLM18AG151SN1	10	150 $\Omega$ ±25%	500	0.25
3	BLM18AG221SN1	10	220 $\Omega$ ±25%	500	0.25
4	BLM18AG331SN1	10	330 $\Omega$ ±25%	500	0.30
5	BLM18AG471SN1	10	470 $\Omega$ ±25%	500	0.35
6	BLM18AG601SN1	10	600 $\Omega$ ±25%	500	0.38
7	BLM18AG102SN1	10	1000 $\Omega$ ±25%	400	0.50
8	BLM18BA050SN1	10	5 $\Omega$ ±25%	500	0.20
9	BLM18BA100SN1	10	10 $\Omega$ ±25%	500	0.25
10	BLM18BA470SN1	10	47 $\Omega$ ±25%	300	0.55
11	BLM18BA750SN1	10	75 $\Omega$ ±25%	300	0.70
12	BLM18BA121SN1	10	120 $\Omega$ ±25%	200	0.90
13	BLM18BB050SN1	10	5 $\Omega$ ±25%	700	0.05
14	BLM18BB100SN1	10	10 $\Omega$ ±25%	700	0.10
15	BLM18BB220SN1	10	22 $\Omega$ ±25%	600	0.20
16	BLM18BB470SN1	10	47 $\Omega$ ±25%	550	0.25
17	BLM18BB600SN1	10	60 $\Omega$ ±25%	550	0.25
18	BLM18BB750SN1	10	75 $\Omega$ ±25%	500	0.30
19	BLM18BB121SN1	10	120 $\Omega$ ±25%	500	0.30
20	BLM18BB151SN1	10	150 $\Omega$ ±25%	450	0.37
21	BLM18BB221SN1	10	220 $\Omega$ ±25%	450	0.45
22	BLM18BB331SN1	10	330 $\Omega$ ±25%	400	0.58

Continued on the following page. 

△Note • Please read rating and △CAUTION (for storage, operating, rating, soldering, mounting and handling) in this catalog to prevent smoking and/or burning, etc.  
 • This catalog has only typical specifications because there is no space for detailed specifications. Therefore, please review our product specifications or consult the approval sheet for product specifications before ordering.

Continued from the preceding page.

No.	Part Number	Quantity (pcs.)	Impedance typ. (at 100MHz, 20 degrees C)	Rated Current (mA)	DC Resistance (Ω) max.
23	BLM18BB471SN1	10	470Ω±25%	300	0.85
24	BLM18BD470SN1	10	47Ω±25%	200	0.30
25	BLM18BD121SN1	10	120Ω±25%	200	0.40
26	BLM18BD151SN1	10	150Ω±25%	200	0.40
27	BLM18BD221SN1	10	220Ω±25%	200	0.45
28	BLM18BD331SN1	10	330Ω±25%	200	0.50
29	BLM18BD421SN1	10	420Ω±25%	200	0.55
30	BLM18BD471SN1	10	470Ω±25%	200	0.55
31	BLM18BD601SN1	10	600Ω±25%	200	0.65
32	BLM18BD102SN1	10	1000Ω±25%	100	0.85
33	BLM18BD152SN1	10	1500Ω±25%	50	1.20
34	BLM18BD182SN1	10	1800Ω±25%	50	1.50
35	BLM18BD222SN1	10	2200Ω±25%	50	1.50
36	BLM18BD252SN1	10	2500Ω±25%	50	1.50
37	BLM18PG300SN1	10	30Ω (Typ.)	1000	0.05
38	BLM18PG330SN1	10	33Ω±25%	3000	0.025
39	BLM18PG600SN1	10	60Ω (Typ.)	500	0.10
40	BLM18PG121SN1	10	120Ω±25%	2000	0.05
41	BLM18PG181SN1	10	180Ω±25%	1500	0.09
42	BLM18PG221SN1	10	220Ω±25%	1400	0.10
43	BLM18PG331SN1	10	330Ω±25%	1200	0.15
44	BLM18PG471SN1	10	470Ω±25%	1000	0.20
45	BLM18KG260TN1	10	26Ω±25%	6000	0.007
46	BLM18KG300TN1	10	30Ω±25%	5000	0.010
47	BLM18KG700TN1	10	70Ω±25%	3500	0.022
48	BLM18KG101TN1	10	100Ω±25%	3000	0.030
49	BLM18KG121TN1	10	120Ω±25%	3000	0.030
50	BLM18KG221SN1	10	220Ω±25%	2200	0.050
51	BLM18KG331SN1	10	330Ω±25%	1700	0.080
52	BLM18KG471SN1	10	470Ω±25%	1500	0.130
53	BLM18KG601SN1	10	600Ω±25%	1300	0.150
54	BLM18SG260TN1	10	26Ω±25%	6000	0.007
55	BLM18SG700TN1	10	70Ω±25%	4000	0.020
56	BLM18SG121TN1	10	120Ω±25%	3000	0.025
57	BLM18SG221TN1	10	220Ω±25%	2500	0.040
58	BLM18SG331TN1	10	330Ω±25%	1500	0.070

●EKEMBL8GA (Chip Ferrite Beads 0603 Size / for High Frequency Type)

No.	Part Number	Quantity (pcs.)	Impedance (at 100MHz, 20 degrees C)	Impedance (at 1GHz, 20 degrees C)	Rated Current (mA)	DC Resistance (Ω) max.
1	BLM18HG471SN1	10	470Ω±25%	600Ω (Typ.)	200	0.85
2	BLM18HG601SN1	10	600Ω±25%	700Ω (Typ.)	200	1.00
3	BLM18HG102SN1	10	1000Ω±25%	1000Ω (Typ.)	100	1.60
4	BLM18HB121SN1	10	120Ω±25%	500Ω±40%	200	0.50
5	BLM18HB221SN1	10	220Ω±25%	1100Ω±40%	100	0.80
6	BLM18HB331SN1	10	330Ω±25%	1600Ω±40%	50	1.20
7	BLM18HD471SN1	10	470Ω±25%	1000Ω (Typ.)	100	1.20
8	BLM18HD601SN1	10	600Ω±25%	1200Ω (Typ.)	100	1.50
9	BLM18HD102SN1	10	1000Ω±25%	1700Ω (Typ.)	50	1.80
10	BLM18HE601SN1	10	600Ω±25%	600Ω (Typ.)	800	0.25
11	BLM18HE102SN1	10	1000Ω±25%	1000Ω (Typ.)	600	0.35
12	BLM18HE152SN1	10	1500Ω±25%	1500Ω (Typ.)	500	0.50
13	BLM18HK331SN1	10	330Ω±25%	400Ω (Typ.)	200	0.50
14	BLM18HK471SN1	10	470Ω±25%	600Ω (Typ.)	200	0.70
15	BLM18HK601SN1	10	600Ω±25%	700Ω (Typ.)	100	0.90
16	BLM18HK102SN1	10	1000Ω±25%	1200Ω (Typ.)	50	1.50
17	BLM18EG101TN1	10	100Ω±25%	140Ω (Typ.)	2000	0.045
18	BLM18EG121SN1	10	120Ω±25%	145Ω (Typ.)	2000	0.04
19	BLM18EG221TN1	10	220Ω±25%	300Ω (Typ.)	1000	0.15
20	BLM18EG221SN1	10	220Ω±25%	260Ω (Typ.)	2000	0.05
21	BLM18EG331TN1	10	330Ω±25%	450Ω (Typ.)	500	0.21
22	BLM18EG391TN1	10	390Ω±25%	520Ω (Typ.)	500	0.30
23	BLM18EG471SN1	10	470Ω±25%	550Ω (Typ.)	500	0.21
24	BLM18EG601SN1	10	600Ω±25%	700Ω (Typ.)	500	0.35
25	BLM18GG471SN1	10	470Ω±25%	1800Ω±30%	200	1.30

△Note • Please read rating and △CAUTION (for storage, operating, rating, soldering, mounting and handling) in this catalog to prevent smoking and/or burning, etc.  
 • This catalog has only typical specifications because there is no space for detailed specifications. Therefore, please review our product specifications or consult the approval sheet for product specifications before ordering.

Chip Ferrite Bead  
Design Kits  
Chip EMIFIL®  
Chip Common Mode Choke Coil  
Block Type EMIFIL®

## ●EKEMBL21E (Chip Ferrite Beads 0805 Size / for Large-current P Type)

No.	Part Number	Quantity (pcs.)	Impedance typ. (at 100MHz, 20 degrees C)	Rated Current (mA)	DC Resistance ( $\Omega$ ) max.
1	BLM21AG121SN1	10	120 $\Omega$ ±25%	200	0.15
2	BLM21AG151SN1	10	150 $\Omega$ ±25%	200	0.15
3	BLM21AG221SN1	10	220 $\Omega$ ±25%	200	0.20
4	BLM21AG331SN1	10	330 $\Omega$ ±25%	200	0.25
5	BLM21AG471SN1	10	470 $\Omega$ ±25%	200	0.25
6	BLM21AG601SN1	10	600 $\Omega$ ±25%	200	0.30
7	BLM21AG102SN1	10	1000 $\Omega$ ±25%	200	0.45
8	BLM21BB050SN1	10	5 $\Omega$ ±25%	500	0.07
9	BLM21BB600SN1	10	60 $\Omega$ ±25%	200	0.20
10	BLM21BB750SN1	10	75 $\Omega$ ±25%	200	0.25
11	BLM21BB121SN1	10	120 $\Omega$ ±25%	200	0.25
12	BLM21BB221SN1	10	220 $\Omega$ ±25%	200	0.35
13	BLM21BB331SN1	10	330 $\Omega$ ±25%	200	0.40
14	BLM21BB471SN1	10	470 $\Omega$ ±25%	200	0.45
15	BLM21BD121SN1	10	120 $\Omega$ ±25%	200	0.25
16	BLM21BD221SN1	10	220 $\Omega$ ±25%	200	0.25
17	BLM21BD421SN1	10	420 $\Omega$ ±25%	200	0.30
18	BLM21BD471SN1	10	470 $\Omega$ ±25%	200	0.35
19	BLM21BD601SN1	10	600 $\Omega$ ±25%	200	0.35
20	BLM21BD102SN1	10	1000 $\Omega$ ±25%	200	0.40
21	BLM21BD152SN1	10	1500 $\Omega$ ±25%	200	0.45
22	BLM21BD182SN1	10	1800 $\Omega$ ±25%	200	0.50
23	BLM21BD222SN1	10	2250 $\Omega$ (Typ.)	200	0.60
24	BLM21BD222TN1	10	2200 $\Omega$ ±25%	200	0.60
25	BLM21BD272SN1	10	2700 $\Omega$ ±25%	200	0.80
26	BLM21PG220SN1	10	22 $\Omega$ ±25%	6000	0.01
27	BLM21PG300SN1	10	30 $\Omega$ (Typ.)	3000	0.015
28	BLM21PG600SN1	10	60 $\Omega$ ±25%	3000	0.025
29	BLM21PG121SN1	10	120 $\Omega$ ±25%	3000	0.03
30	BLM21PG221SN1	10	220 $\Omega$ ±25%	2000	0.050
31	BLM21PG331SN1	10	330 $\Omega$ ±25%	1500	0.09
32	BLM31PG330SN1	10	33 $\Omega$ ±25%	6000	0.01
33	BLM31PG500SN1	10	50 $\Omega$ (Typ.)	3000	0.025
34	BLM31PG121SN1	10	120 $\Omega$ ±25%	3000	0.025
35	BLM31PG391SN1	10	390 $\Omega$ (Typ.)	2000	0.05
36	BLM31PG601SN1	10	600 $\Omega$ (Typ.)	1500	0.09
37	BLM41PG600SN1	10	60 $\Omega$ (Typ.)	6000	0.01
38	BLM41PG750SN1	10	75 $\Omega$ (Typ.)	3000	0.025
39	BLM41PG181SN1	10	180 $\Omega$ (Typ.)	3000	0.025
40	BLM41PG471SN1	10	470 $\Omega$ (Typ.)	2000	0.05
41	BLM41PG102SN1	10	1000 $\Omega$ (Typ.)	1500	0.09

△Note • Please read rating and △CAUTION (for storage, operating, rating, soldering, mounting and handling) in this catalog to prevent smoking and/or burning, etc.  
 • This catalog has only typical specifications because there is no space for detailed specifications. Therefore, please review our product specifications or consult the approval sheet for product specifications before ordering.